



## EXTERIOR+INTERIOR SIGNS

---

- Wayfinding
  - Regulatory+Warning Signs
  - Level+Isle Markers
  - Parking Rate Signs
  - Traffic Signs
- 

---

## ARCHITECTURAL SIGNAGE

---

INTERIOR + EXTERIOR



# PARKING GARAGE SIGNAGE CATALOG

45+

YEARS OF EXPERIENCE.  
MANUFACTURING+INSTALLING ARCHITECTURAL SIGNAGE  
IN NEW YORK CITY

# TABLE OF CONTENTS

## CONTENTS

Information: ..... 4

About Us ..... 5

Parking Signs ..... 6

Open Signs ..... 24

Entrance Signs ..... 28

Exit Signs ..... 37

Wayfinding Signs ..... 45

Clearance Signs ..... 66

Informational Signs ..... 67

Changeable Outdoor+Indoor Signs ..... 82

Level+Aisle Markers ..... 84

Stair+Elevator Signs ..... 89

Ada Compliant Signs ..... 94

Rate Signs+Sign Frame ..... 103

Traffic Signs ..... 105

Our Parking Garage Signage Projects ..... 108

Ordering Information/Order Form ..... 120

Design Your Own Sign Form ..... 122

Notes ..... 123

## INFORMATION:

- All Aluminum Signs Are Non-Reflective, With Silkscreens And Vinyl Graphics
- All ADA Compliant Signs Have Grade II Braille And Are Made Of Zinc Suitable For Indoor Or Outdoor Use
- Special Order For Reflective Lettering Is Available
- All Traffic Signs On Pages 105-107 Are Engineering Grade Reflectorized
- See Pages 112-118 For Fabrication And Installation Information
- You May View More Signage Products On Our Website

NOTE: ALL PREVIEWS SHOWN ARE NOT TO SCALE. ALL SIGN SIZES HAVE A HALF INCH ACCENT LINE AT BOTTOM



# SIGNS+DECAL CORP.

## ABOUT US

We are the leading parking garage signage fabricator in the United States. Founded in 1971 by Babu Khalfan, Signs+Decal continues to set new standards for high-quality signage.

For over 45 years we have been a part of the construction industry in New York City and have successfully worked on signage projects with major contractors, developers, architects, and designers. When you give us the opportunity to work on your signage project, our family along with a team of highly qualified and trained professionals are involved from start to finish.

We are always upgrading our facility with state-of-the-art equipment. We use the newest technology, processes, and materials keeping our environment in mind. We also owe our success to the quality of work we produce, efficiency, speed, and our competitive prices.

Using our years of experience, we have designed this catalog to fulfill a parking garage owner's every signage need. Your parking garage will be enhanced with our easy-to-follow signage system. However if your requirements are any different please contact us and we will always be willing to accommodate you.



### WE ARE RESPONSIBLE FOR A GREAT DEAL OF THE LARGE-SCALE PARKING GARAGE SIGNAGE CURRENTLY IN USE:

- Red, Yellow, And Orange Garage At JFK International Airport, NY
- Mets Stadium- Citi Field Parking Lot, Queens, NY
- Solo W 57 Building Parking Garage, Manhattan, NY
- Long Island Jewish Medical Center Parking Garage, NY
- Morristown Parking Garage, NJ
- Largo Town Center Station Parking Garages, Washington, D.C.
- Prudential Center Parking Garage, NJ
- City Of Summit, NJ



NOTE: ALL PREVIEWS SHOWN ARE NOT TO SCALE. ALL SIGN SIZES HAVE A HALF INCH ACCENT LINE AT BOTTOM

**SIGNS+DECAL**  
410 MORGAN AVE.  
BROOKLYN, NY 11211  
T | 718. 466. 6400  
F | 718. 388. 3166  
www.signsanddecal.com  
salesadmin@signsanddecal.com

# PARKING SIGNS

## SIGN TYPE EP-101

- Aluminum Fabricated Panel
- Baked Enamel Finish
- Available In 3 Colors



Available in three sizes (H x W):

12" x 48"

18" x 72"

24" x 96"

Choose arrow direction, colors, and text below, letters A thru O.

Purchase two panels to create a double sided sign; for example B+C or C+D.

Double-sided non-illuminated signs are 2" deep; illuminated signs are 8" to 12" deep.

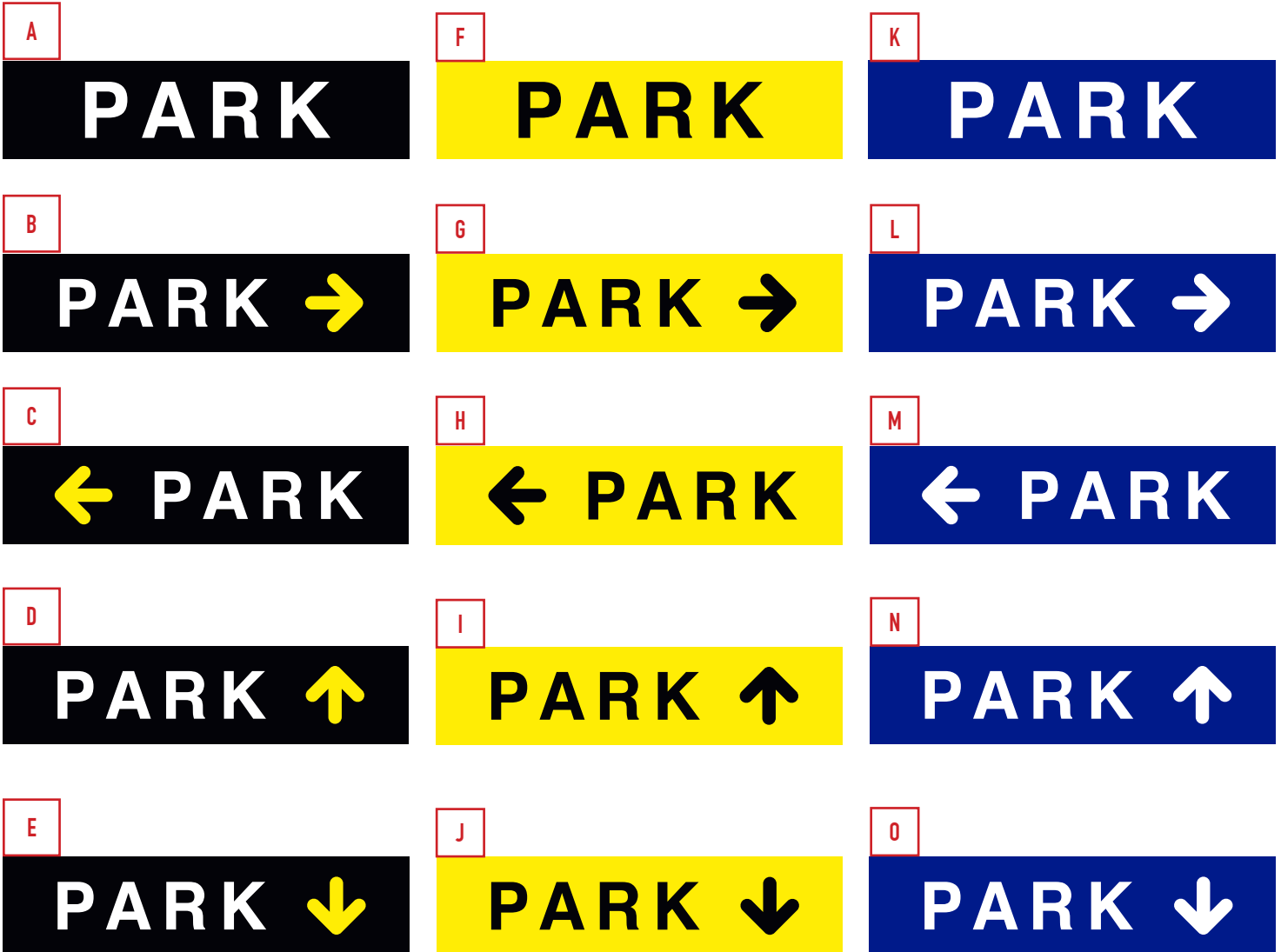

NOTE: ALL PREVIEWS SHOWN ARE NOT TO SCALE. ALL SIGN SIZES HAVE A HALF INCH ACCENT LINE AT BOTTOM



# PARKING SIGNS

## SIGN TYPE EP-102

- Aluminum Fabricated Panel
- Baked Enamel Finish
- Available In 3 Colors



Available in three sizes (H x W):

18" x 48"

27" x 72"

36" x 96"

Choose arrow direction, colors, and text below, letters A thru L.

Purchase two panels to create a double sided sign; for example A+B or C+D.

Double-sided non-illuminated signs are 2" deep; illuminated signs are 8" to 12" deep.



NOTE: ALL PREVIEWS SHOWN ARE NOT TO SCALE. ALL SIGN SIZES HAVE A HALF INCH ACCENT LINE AT BOTTOM

# PARKING SIGNS

## SIGN TYPE EP-103

- Aluminum Fabricated Panel
- Baked Enamel Finish
- Available In 3 Colors



Available in THREE sizes (H x W):

12" x 48"

18" x 72"

24" x 96"

Choose arrow direction, colors, and text below, letters A thru L.

Purchase two panels to create a double sided sign; for example B+C or C+D.

Double-sided non-illuminated signs are 2" deep; illuminated signs are 8" to 12" deep.

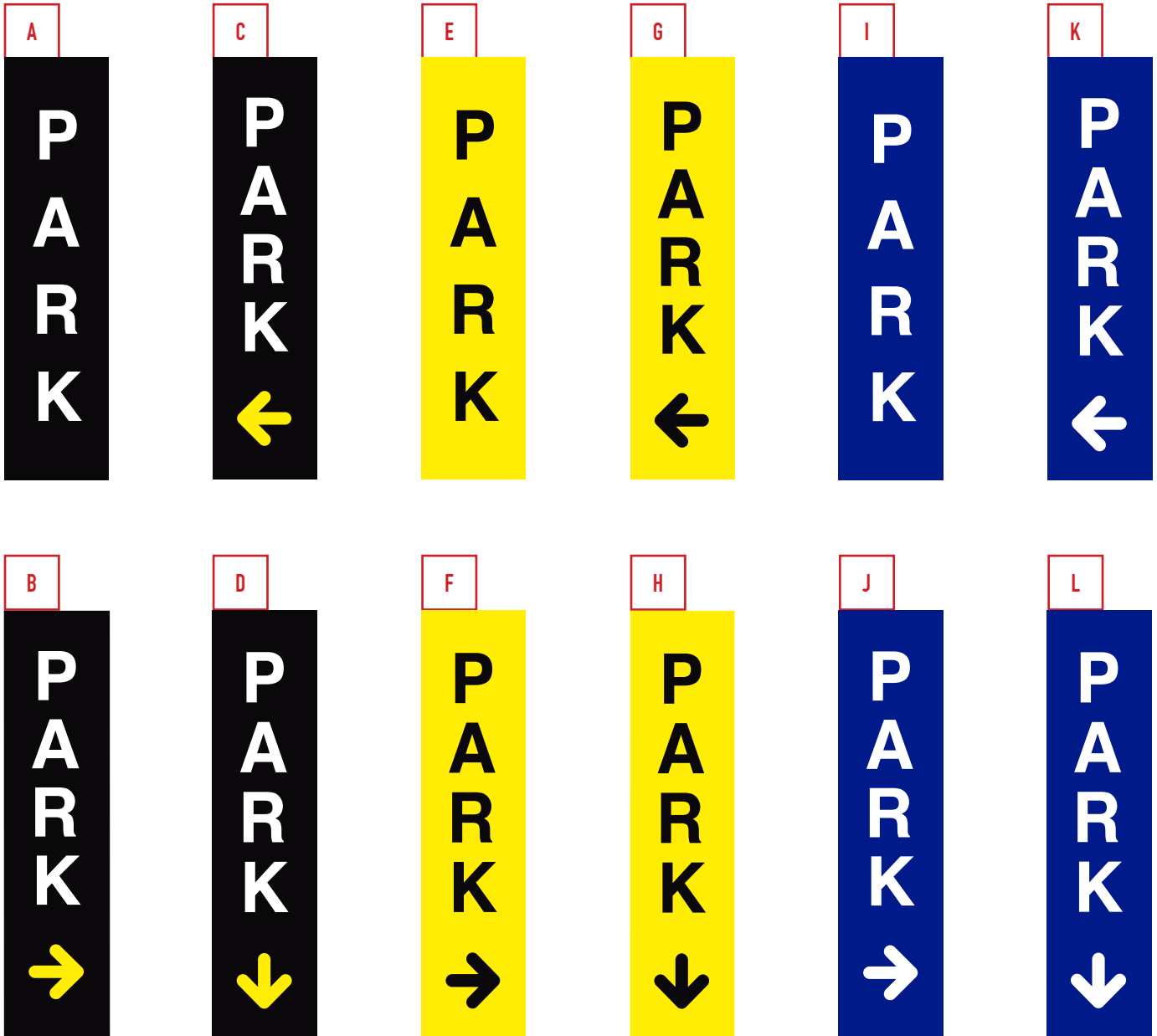

NOTE: ALL PREVIEWS SHOWN ARE NOT TO SCALE. ALL SIGN SIZES HAVE A HALF INCH ACCENT LINE AT BOTTOM



# PARKING SIGNS

## SIGN TYPE EP-104

- Aluminum Fabricated Panel
- Baked Enamel Finish
- Available In 3 Colors



Available in THREE sizes (H x W):

18" x 48"

27" x 72"

36" x 96"

Choose arrow direction, colors, and text below, letters A thru O.

Purchase two panels to create a double sided sign; for example A+B or C+D.

Double-sided non-illuminated signs are 2" deep; illuminated signs are 8" to 12" deep.



NOTE: ALL PREVIEWS SHOWN ARE NOT TO SCALE. ALL SIGN SIZES HAVE A HALF INCH ACCENT LINE AT BOTTOM

# PARKING SIGNS

## SIGN TYPE EP-105

- Aluminum Fabricated Panel
- Baked Enamel Finish
- Available In 3 Colors



Available in THREE sizes (H x W):

12" x 48"

18" x 72"

24" x 96"

Choose arrow direction, colors, and text below, letters A thru L.

Purchase two panels to create a double sided sign; for example B+C or C+D.

Double-sided non-illuminated signs are 2" deep; illuminated signs are 8" to 12" deep.



NOTE: ALL PREVIEWS SHOWN ARE NOT TO SCALE. ALL SIGN SIZES HAVE A HALF INCH ACCENT LINE AT BOTTOM





# PARKING SIGNS

## SIGN TYPE EP-106

- Aluminum Fabricated Panel
- Baked Enamel Finish
- Available In 3 Colors



Available in THREE sizes (H x W):

18" x 48"

27" x 72"

36" x 96"

Choose arrow direction, colors, and text below, letters A thru L.

Purchase two panels to create a double sided sign; for example A+B or C+D.

Double-sided non-illuminated signs are 2" deep; illuminated signs are 8" to 12" deep.



NOTE: ALL PREVIEWS SHOWN ARE NOT TO SCALE. ALL SIGN SIZES HAVE A HALF INCH ACCENT LINE AT BOTTOM

# PARKING SIGNS

## SIGN TYPE EP-303

- Aluminum Fabricated Panel
- Baked Enamel Finish
- Available In 3 Colors



Available in THREE sizes (H x W):

24" x 36"

36" x 54"

48" x 72"

Choose arrow direction, colors, and text below, letters A thru L.

Purchase two panels to create a double sided sign; for example B+C or C+D.

Double-sided non-illuminated signs are 2" deep; illuminated signs are 8" to 12" deep.

A



C



E



B



D



F



NOTE: ALL PREVIEWS SHOWN ARE NOT TO SCALE. ALL SIGN SIZES HAVE A HALF INCH ACCENT LINE AT BOTTOM



# PARKING SIGNS

## SIGN TYPE EP-401

- Aluminum Fabricated Panel
- Baked Enamel Finish
- Available In 3 Colors



Available in THREE sizes (H x W):

48"

36"

30"

Choose arrow direction, colors, and text below, letters A thru C.

Purchase two panels to create a double sided sign; for example A+A or B+C.

Double-sided non-illuminated signs are 2" deep; illuminated signs are 8" to 12" deep.

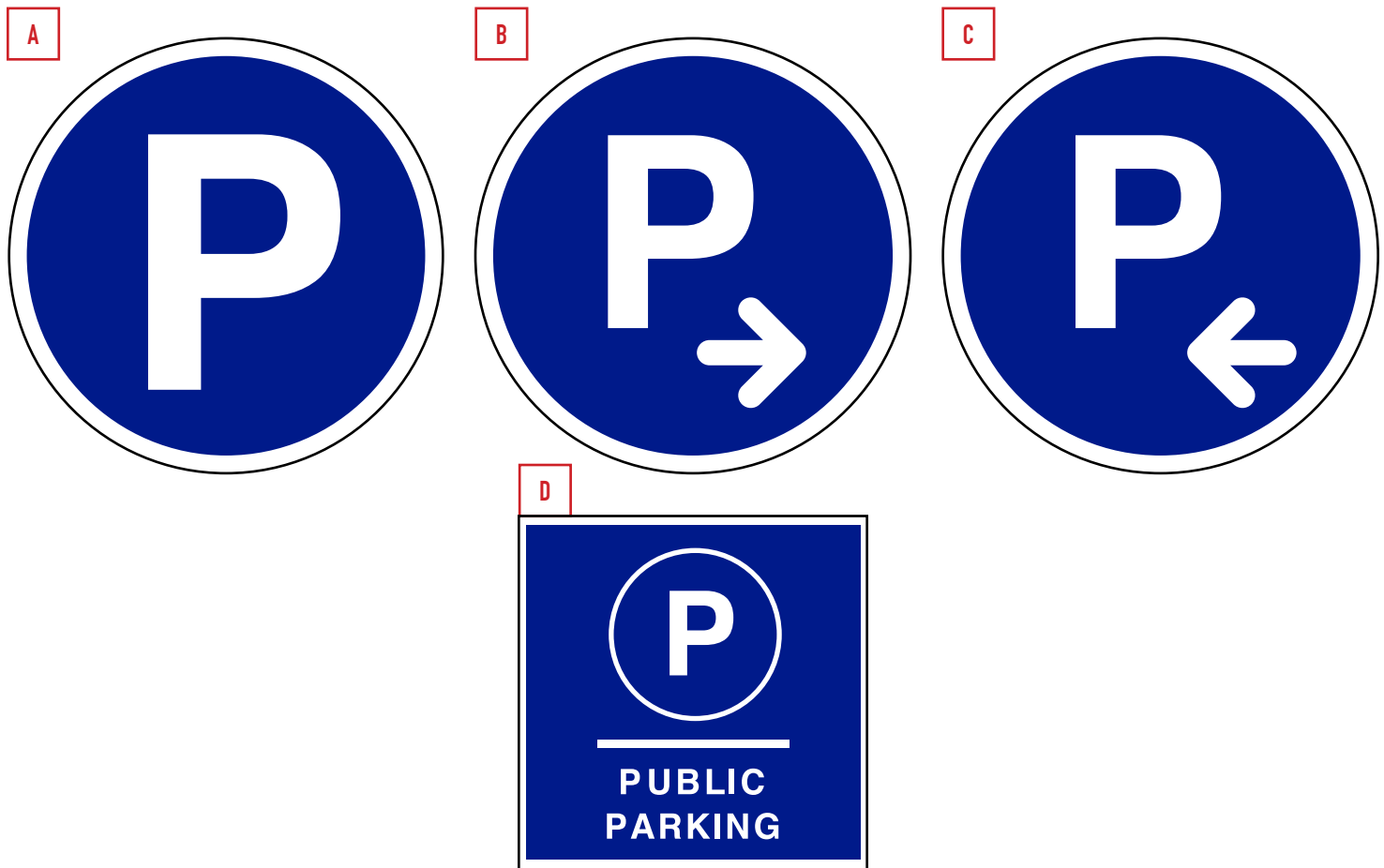

NOTE: ALL PREVIEWS SHOWN ARE NOT TO SCALE. ALL SIGN SIZES HAVE A HALF INCH ACCENT LINE AT BOTTOM

# PARKING SIGNS

## **SIGN TYPE EP-201**

- Aluminum Fabricated Panel
- Baked Enamel Finish
- Available In 3 Colors

Available in TWO sizes (H x W):

16" x 12"

24" x 18'

Choose arrow direction, colors, and text below, letters A thru I.

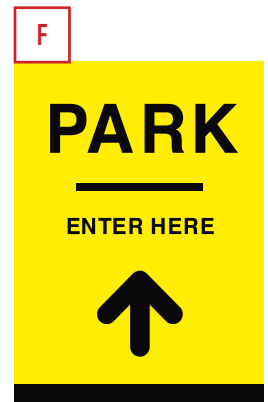
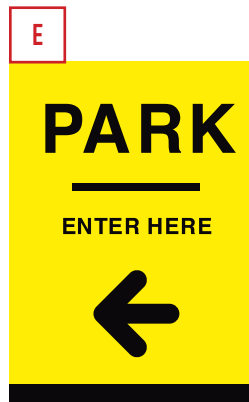

NOTE: ALL PREVIEWS SHOWN ARE NOT TO SCALE. ALL SIGN SIZES HAVE A HALF INCH ACCENT LINE AT BOTTOM



# PARKING SIGNS

## **SIGN TYPE EP-202**

- Aluminum Fabricated Panel
- Baked Enamel Finish
- Available In 3 Colors

Available in TWO sizes (H x W):

16" x 12"

24" x 18'

Choose arrow direction, colors, and text below, letters A thru I.

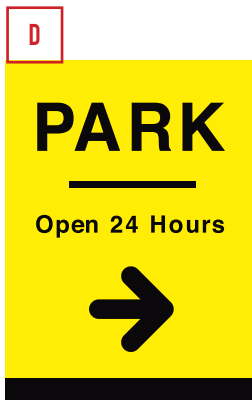
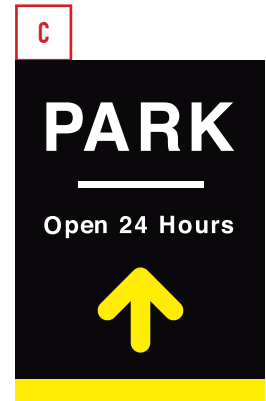
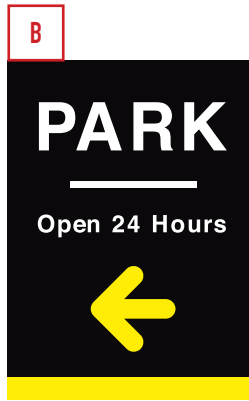
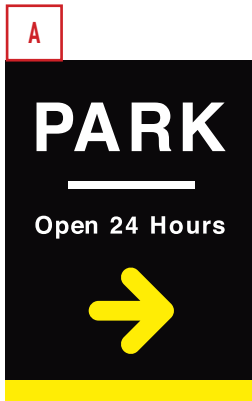

NOTE: ALL PREVIEWS SHOWN ARE NOT TO SCALE. ALL SIGN SIZES HAVE A HALF INCH ACCENT LINE AT BOTTOM

# PARKING SIGNS

## **SIGN TYPE EP-203**

- Aluminum Fabricated Panel
- Baked Enamel Finish
- Available In 3 Colors

Available in TWO sizes (H x W):

16" x 12"

24" x 18'

Choose arrow direction, colors, and text below, letters A thru L.



NOTE: ALL PREVIEWS SHOWN ARE NOT TO SCALE. ALL SIGN SIZES HAVE A HALF INCH ACCENT LINE AT BOTTOM



# PARKING SIGNS

## **SIGN TYPE EP-204+EP-205**

- Aluminum Fabricated Panel
- Baked Enamel Finish
- Available In 3 Colors

Available in TWO sizes (H x W):

16" x 12"

24" x 18"

Choose arrow direction, colors, and text below, letters A thru L.

EP-204

A



C



E



EP-205

B



D



F



NOTE: ALL PREVIEWS SHOWN ARE NOT TO SCALE. ALL SIGN SIZES HAVE A HALF INCH ACCENT LINE AT BOTTOM

# PARKING SIGNS

## **SIGN TYPE EP-203**

- Aluminum Fabricated Panel
- Baked Enamel Finish
- Available In 3 Colors

Available in TWO sizes (H x W):

16" x 12"

24" x 18'

Choose arrow direction, colors, and text below, letters A thru D.



NOTE: ALL PREVIEWS SHOWN ARE NOT TO SCALE. ALL SIGN SIZES HAVE A HALF INCH ACCENT LINE AT BOTTOM



# PARKING SIGNS

## **SIGN TYPE EP-204+EP-205**

- Aluminum Fabricated Panel
- Baked Enamel Finish
- Available In 3 Colors

Available in TWO sizes (H x W):

16" x 12"

24" x 18"

Choose arrow direction, colors, and text below, letters A thru I.

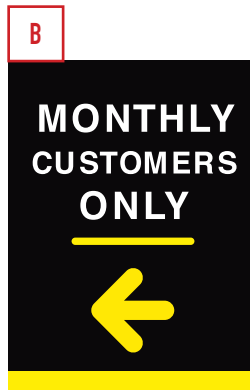

NOTE: ALL PREVIEWS SHOWN ARE NOT TO SCALE. ALL SIGN SIZES HAVE A HALF INCH ACCENT LINE AT BOTTOM

# PARKING SIGNS

## SIGN TYPE EP-201

- Aluminum Fabricated Panel
- Baked Enamel Finish
- Available In 3 Colors

Available in TWO sizes (H x W):  
16" x 12"  
24" x 18'

Choose arrow direction, colors, and text below, letters A thru I.

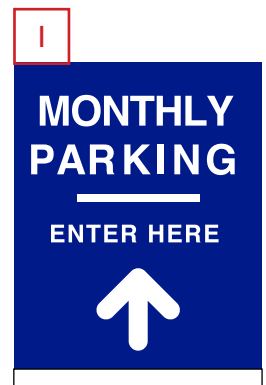
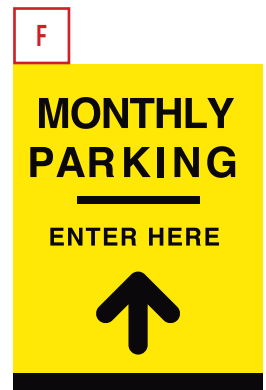
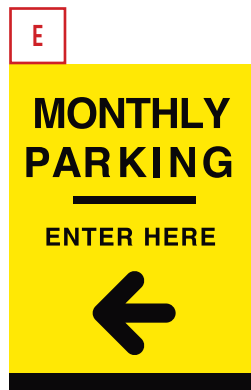
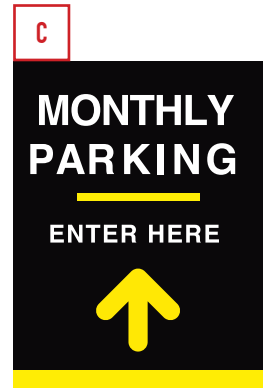

NOTE: ALL PREVIEWS SHOWN ARE NOT TO SCALE. ALL SIGN SIZES HAVE A HALF INCH ACCENT LINE AT BOTTOM



# PARKING SIGNS

## SIGN TYPE EP-202

- Aluminum Fabricated Panel
- Baked Enamel Finish
- Available In 3 Colors

Available in TWO sizes (H x W):

16" x 12"

24" x 18'

Choose arrow direction, colors, and text below, letters A thru I.



NOTE: ALL PREVIEWS SHOWN ARE NOT TO SCALE. ALL SIGN SIZES HAVE A HALF INCH ACCENT LINE AT BOTTOM

# PARKING SIGNS

## SIGN TYPE MF-204 & MF-205

- Aluminum Fabricated Panel
- Baked Enamel Finish
- Available In 3 Colors

Available in TWO sizes (H x W):

16" x 12"

24" x 18"

Choose arrow direction, colors, and text below, letters A thru C.

MF-204



MF-205



NOTE: ALL PREVIEWS SHOWN ARE NOT TO SCALE. ALL SIGN SIZES HAVE A HALF INCH ACCENT LINE AT BOTTOM

# PARKING SIGNS

## **SIGN TYPE MF-301** Available in TWO sizes (H x W):

- Aluminum Fabricated Panel
- Baked Enamel Finish
- Available In 3 Colors

16" x 12"  
24" x 18'

Choose arrow direction, colors, and text below, letters A thru I.



NOTE: ALL PREVIEWS SHOWN ARE NOT TO SCALE. ALL SIGN SIZES HAVE A HALF INCH ACCENT LINE AT BOTTOM

## **SIGN TYPE OH-101**

- Aluminum Fabricated Panel
- Baked Enamel Finish
- Available In 3 Colors

Available in THREE sizes (H x W):  
8" x 32"  
12" x 48"  
18" X 72"

Choose arrow direction, colors, and text below, letters A thru C.



NOTE: ALL PREVIEWS SHOWN ARE NOT TO SCALE. ALL SIGN SIZES HAVE A HALF INCH ACCENT LINE AT BOTTOM

# OPEN SIGNS

## **SIGN TYPE OH-201**

- Aluminum Fabricated Panel
- Baked Enamel Finish
- Available In 3 Colors

Available in TWO sizes (H x W):

16" x 12"

24" x 18"

Choose arrow direction, colors, and text below, letters A thru C.



NOTE: ALL PREVIEWS SHOWN ARE NOT TO SCALE. ALL SIGN SIZES HAVE A HALF INCH ACCENT LINE AT BOTTOM

# OPEN SIGNS

## **SIGN TYPE OH-202** Available in TWO sizes (H x W):

- Aluminum Fabricated Panel
- Baked Enamel Finish
- Available In 3 Colors

16" x 12"  
24" x 18'

Choose arrow direction, colors, and text below, letters A thru I.



NOTE: ALL PREVIEWS SHOWN ARE NOT TO SCALE. ALL SIGN SIZES HAVE A HALF INCH ACCENT LINE AT BOTTOM





# OPEN SIGNS

## **SIGN TYPE OH-203** Available in TWO sizes (H x W):

- Aluminum Fabricated Panel
- Baked Enamel Finish
- Available In 3 Colors

16" x 12"  
24" x 18'

Choose arrow direction, colors, and text below, letters A thru I.

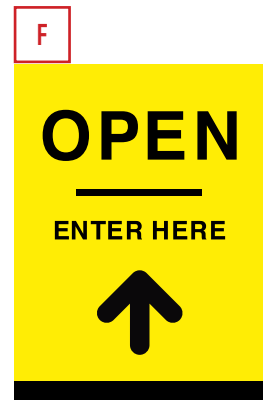
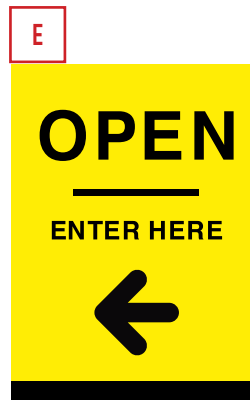
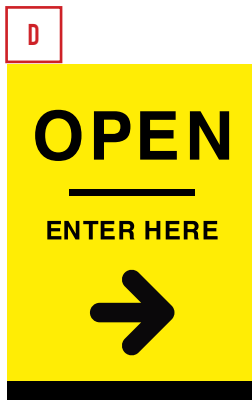
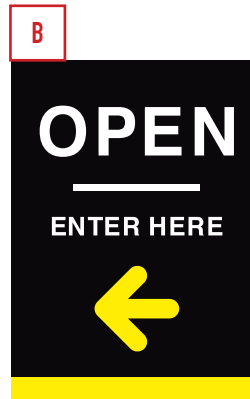

NOTE: ALL PREVIEWS SHOWN ARE NOT TO SCALE. ALL SIGN SIZES HAVE A HALF INCH ACCENT LINE AT BOTTOM

# ENTRANCE SIGNS

## **SIGN TYPE OH-202** Available in TWO sizes (H x W):

- Aluminum Fabricated Panel
- Baked Enamel Finish
- Available In 3 Colors

16" x 12"

24" x 18'

Choose arrow direction, colors, and text below, letters A thru I.



NOTE: ALL PREVIEWS SHOWN ARE NOT TO SCALE. ALL SIGN SIZES HAVE A HALF INCH ACCENT LINE AT BOTTOM

# ENTRANCE SIGNS

## **SIGN TYPE OH-203** Available in TWO sizes (H x W):

- Aluminum Fabricated Panel
- Baked Enamel Finish
- Available In 3 Colors

16" x 12"  
24" x 18'

Choose arrow direction, colors, and text below, letters A thru L.

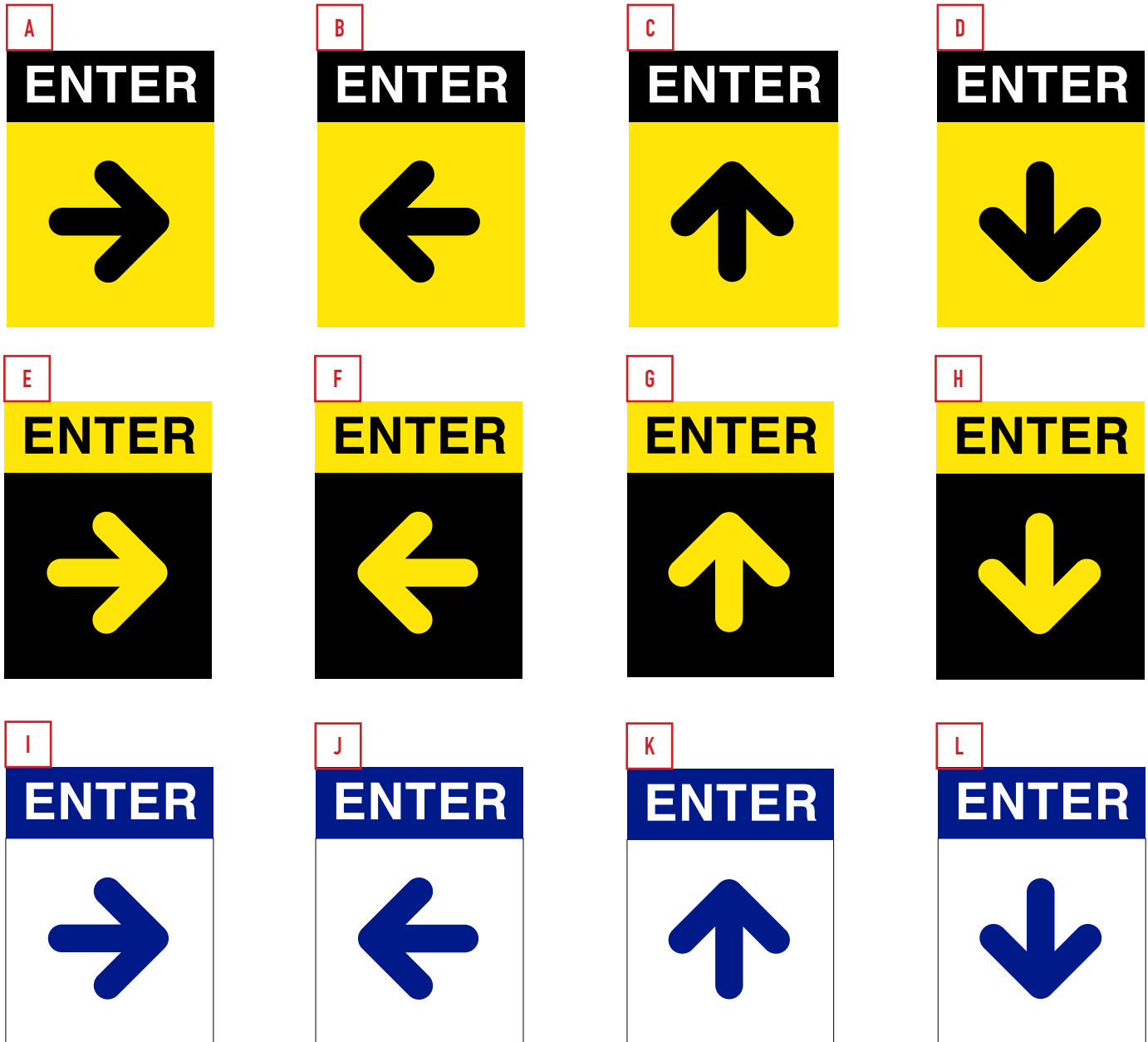

NOTE: ALL PREVIEWS SHOWN ARE NOT TO SCALE. ALL SIGN SIZES HAVE A HALF INCH ACCENT LINE AT BOTTOM

# ENTRANCE SIGNS

## **SIGN TYPE OH-202** Available in TWO sizes (H x W):

16" x 12"

24" x 18"

- Aluminum Fabricated Panel
- Baked Enamel Finish
- Available In 3 Colors

Choose arrow direction, colors, and text below, letters A thru L.

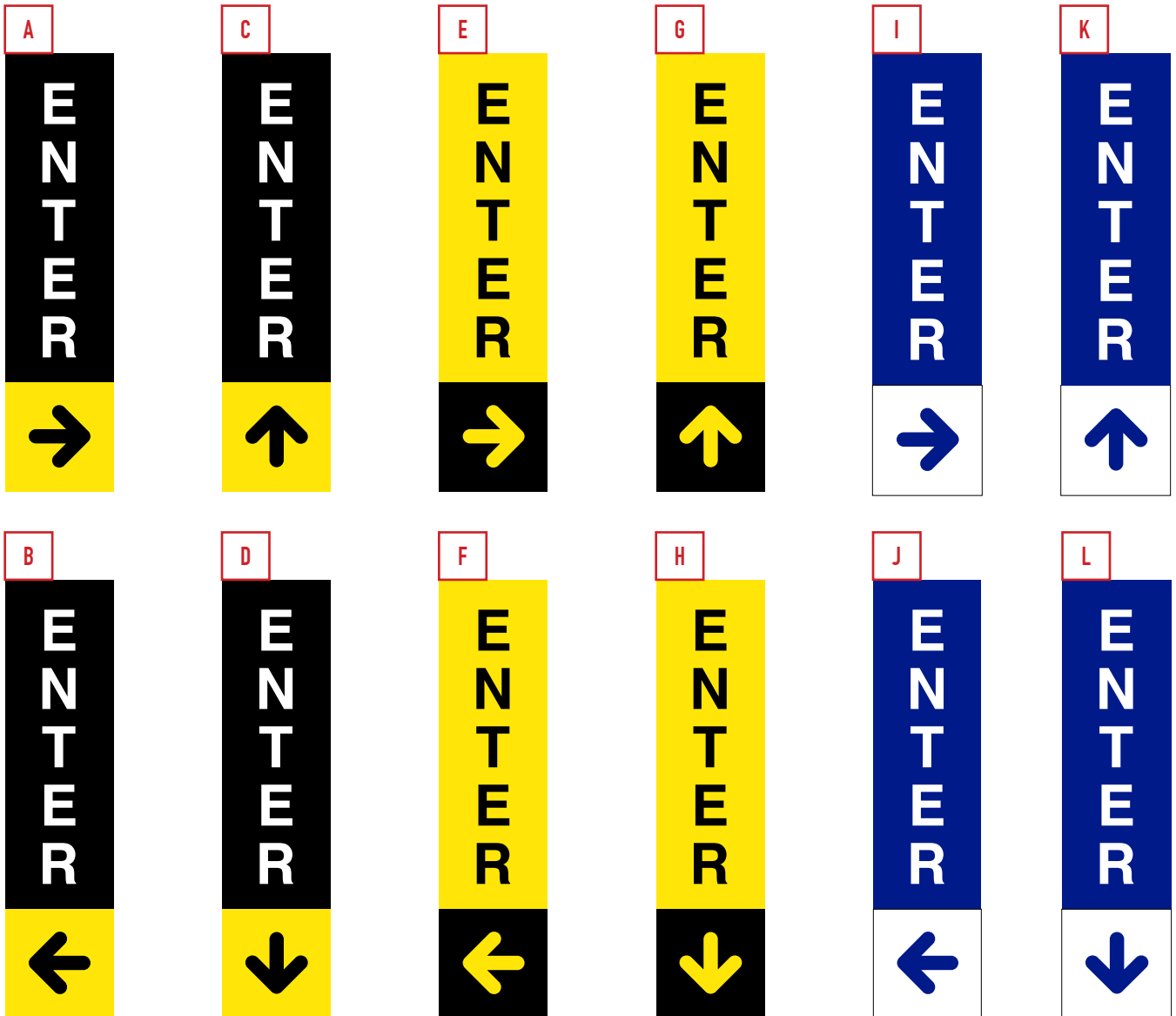

NOTE: ALL PREVIEWS SHOWN ARE NOT TO SCALE. ALL SIGN SIZES HAVE A HALF INCH ACCENT LINE AT BOTTOM

# ENTRANCE SIGNS

## **SIGN TYPE OH-203** Available in TWO sizes (H x W):

- Aluminum Fabricated Panel
- Baked Enamel Finish
- Available In 3 Colors

16" x 12"  
24" x 18'

Choose arrow direction, colors, and text below, letters A thru O.

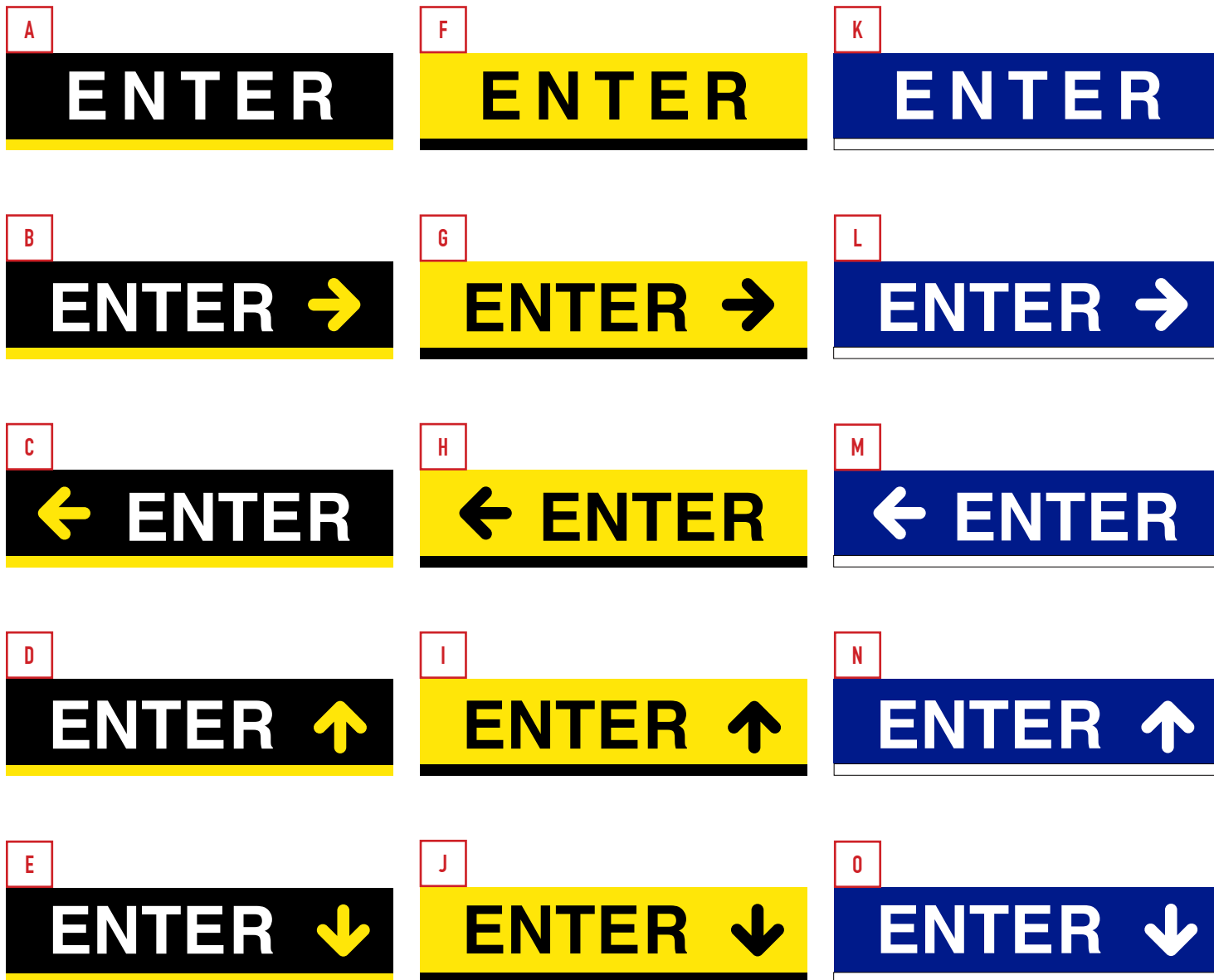

NOTE: ALL PREVIEWS SHOWN ARE NOT TO SCALE. ALL SIGN SIZES HAVE A HALF INCH ACCENT LINE AT BOTTOM

# ENTRANCE SIGNS

## **SIGN TYPE OH-202**

Available in TWO sizes (H x W):

16" x 12"

24" x 18"

- Aluminum Fabricated Panel
- Baked Enamel Finish
- Available In 3 Colors

Choose arrow direction, colors, and text below, letters A thru L.

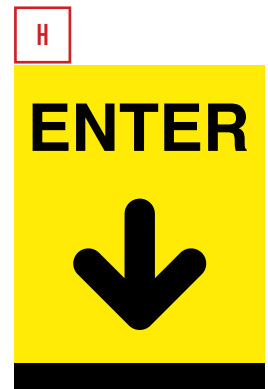

NOTE: ALL PREVIEWS SHOWN ARE NOT TO SCALE. ALL SIGN SIZES HAVE A HALF INCH ACCENT LINE AT BOTTOM

# ENTRANCE SIGNS

## **SIGN TYPE OH-203** Available in TWO sizes (H x W):

16" x 12"

24" x 18'

- Aluminum Fabricated Panel
- Baked Enamel Finish
- Available In 3 Colors

Choose arrow direction, colors, and text below, letters A thru C.



NOTE: ALL PREVIEWS SHOWN ARE NOT TO SCALE. ALL SIGN SIZES HAVE A HALF INCH ACCENT LINE AT BOTTOM

# ENTRANCE SIGNS

## SIGN TYPE OH-202

Available in TWO sizes (H x W):

16" x 12"

24" x 18'

- Aluminum Fabricated Panel
- Baked Enamel Finish
- Available In 3 Colors

Choose arrow direction, colors, and text below, letters A thru C.



NOTE: ALL PREVIEWS SHOWN ARE NOT TO SCALE. ALL SIGN SIZES HAVE A HALF INCH ACCENT LINE AT BOTTOM



# ENTRANCE SIGNS

## **SIGN TYPE OH-203**

- Aluminum Fabricated Panel
- Baked Enamel Finish
- Available In 3 Colors

Available in TWO sizes (H x W):

16" x 12"

24" x 18'

Choose arrow direction, colors, and text below, letters A thru C.

A



B



C

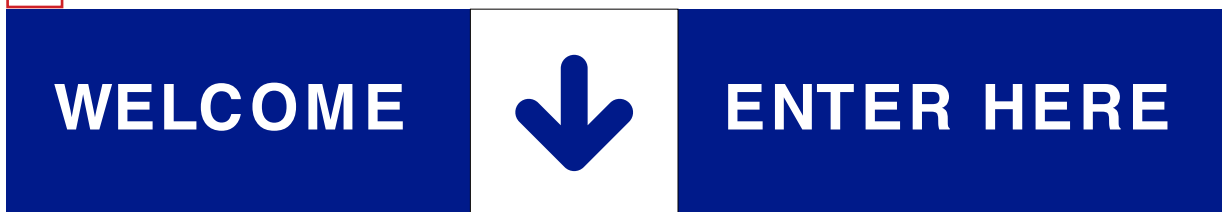

NOTE: ALL PREVIEWS SHOWN ARE NOT TO SCALE. ALL SIGN SIZES HAVE A HALF INCH ACCENT LINE AT BOTTOM

# ENTRANCE SIGNS

## **SIGN TYPE OH-202** Available in TWO sizes (H x W):

16" x 12"

24" x 18'

- Aluminum Fabricated Panel
- Baked Enamel Finish
- Available In 3 Colors

Choose arrow direction, colors, and text below, letters A thru C.

A



B



C



NOTE: ALL PREVIEWS SHOWN ARE NOT TO SCALE. ALL SIGN SIZES HAVE A HALF INCH ACCENT LINE AT BOTTOM

# EXIT SIGNS

## **SIGN TYPE EX-101**

Available in TWO sizes (H x W):

16" x 12"

24" x 18'

- Aluminum Fabricated Panel
- Baked Enamel Finish
- Available In 3 Colors

Choose arrow direction, colors, and text below, letters A thru C.

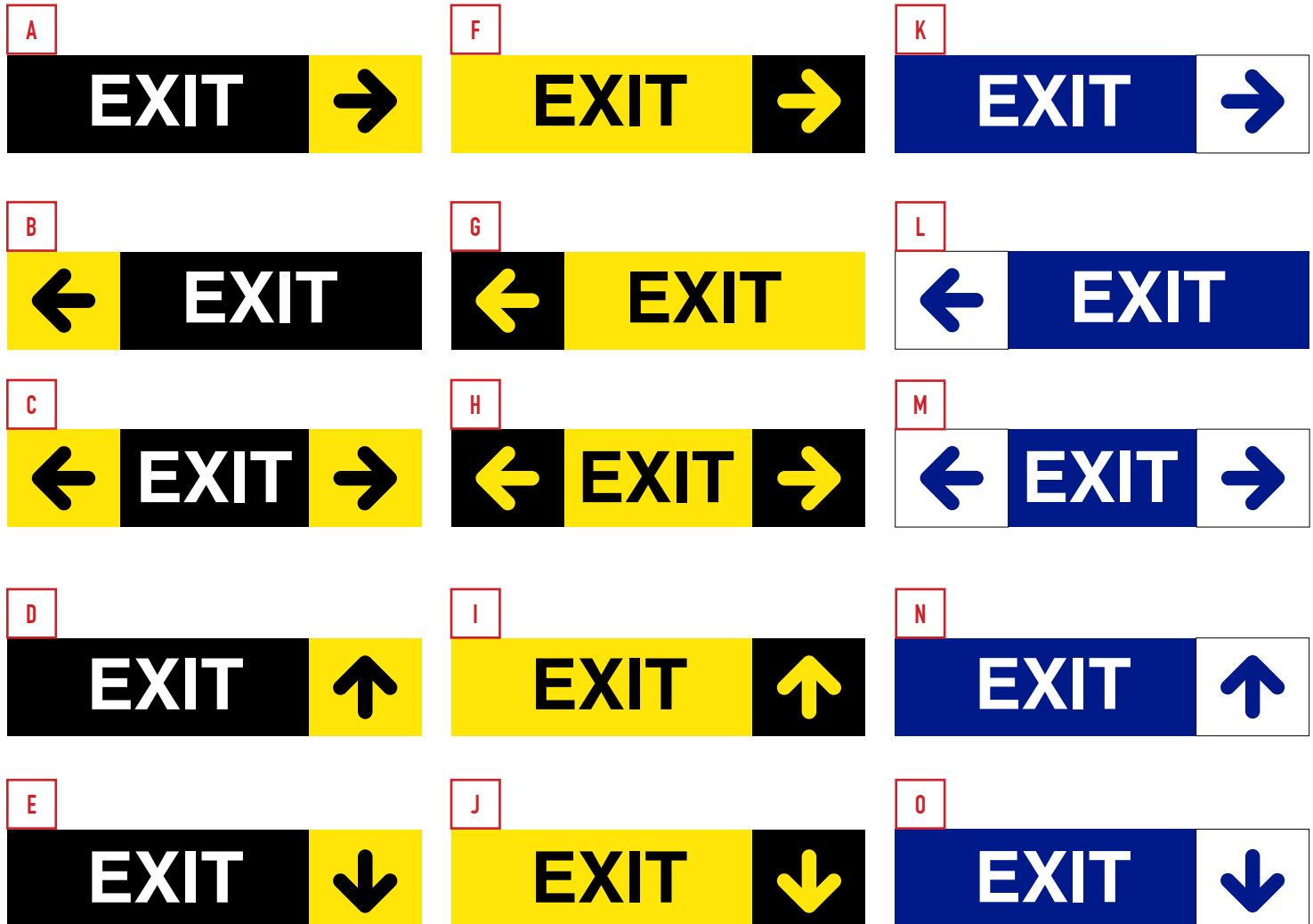

NOTE: ALL PREVIEWS SHOWN ARE NOT TO SCALE. ALL SIGN SIZES HAVE A HALF INCH ACCENT LINE AT BOTTOM

# EXIT SIGNS

## SIGN TYPE EX-201

Available in TWO sizes (H x W):

16" x 12"

24" x 18"

- Aluminum Fabricated Panel
- Baked Enamel Finish
- Available In 3 Colors

Choose arrow direction, colors, and text below, letters A thru L.

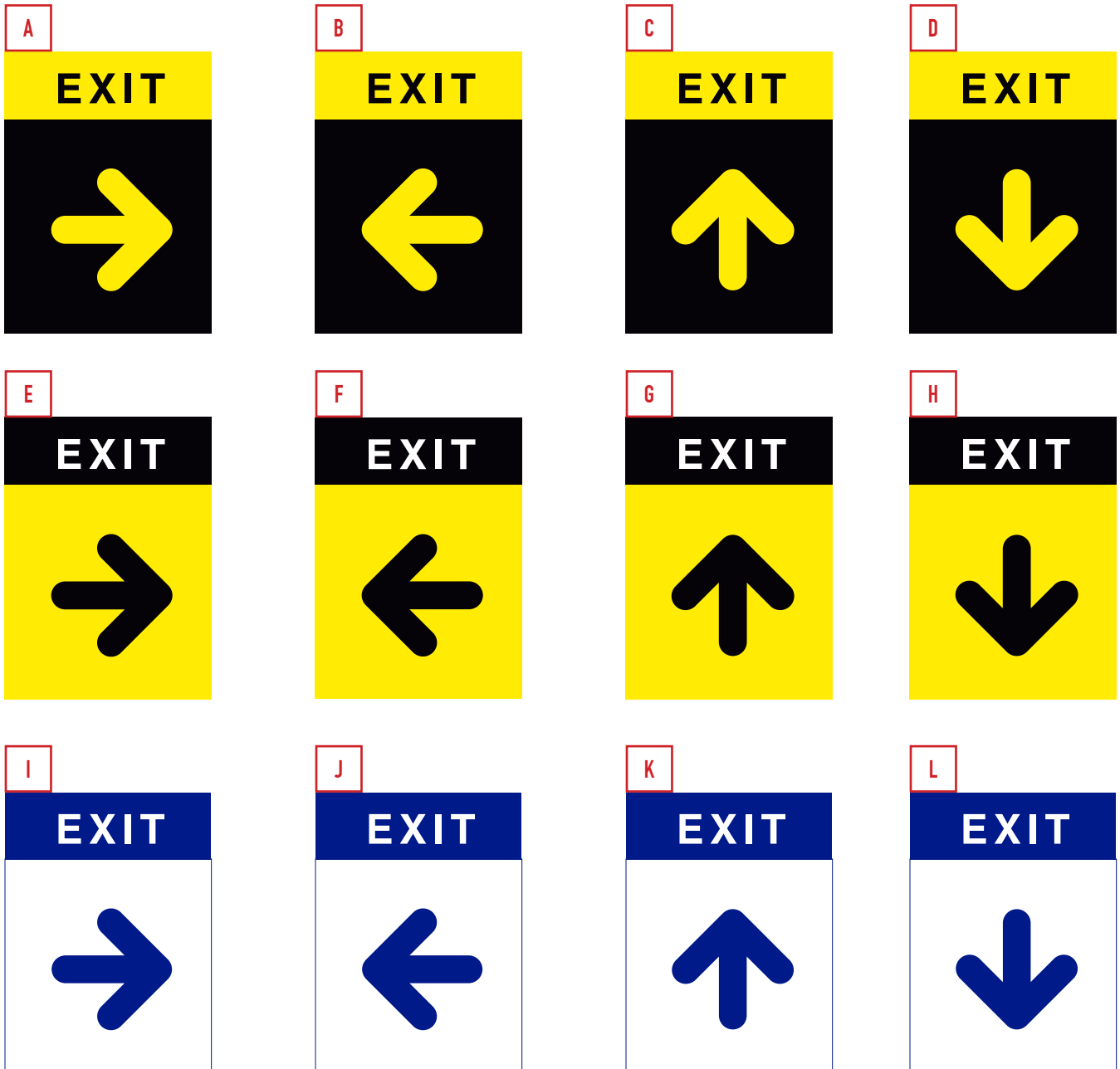

NOTE: ALL PREVIEWS SHOWN ARE NOT TO SCALE. ALL SIGN SIZES HAVE A HALF INCH ACCENT LINE AT BOTTOM

# EXIT SIGNS

## **SIGN TYPE EX-102**

Available in THREE sizes (H x W):

32" x 8"

48" x 12"

72" x 18"

- Aluminum Fabricated Panel
- Baked Enamel Finish
- Available In 3 Colors

Choose arrow direction, colors, and text below, letters A thru L.

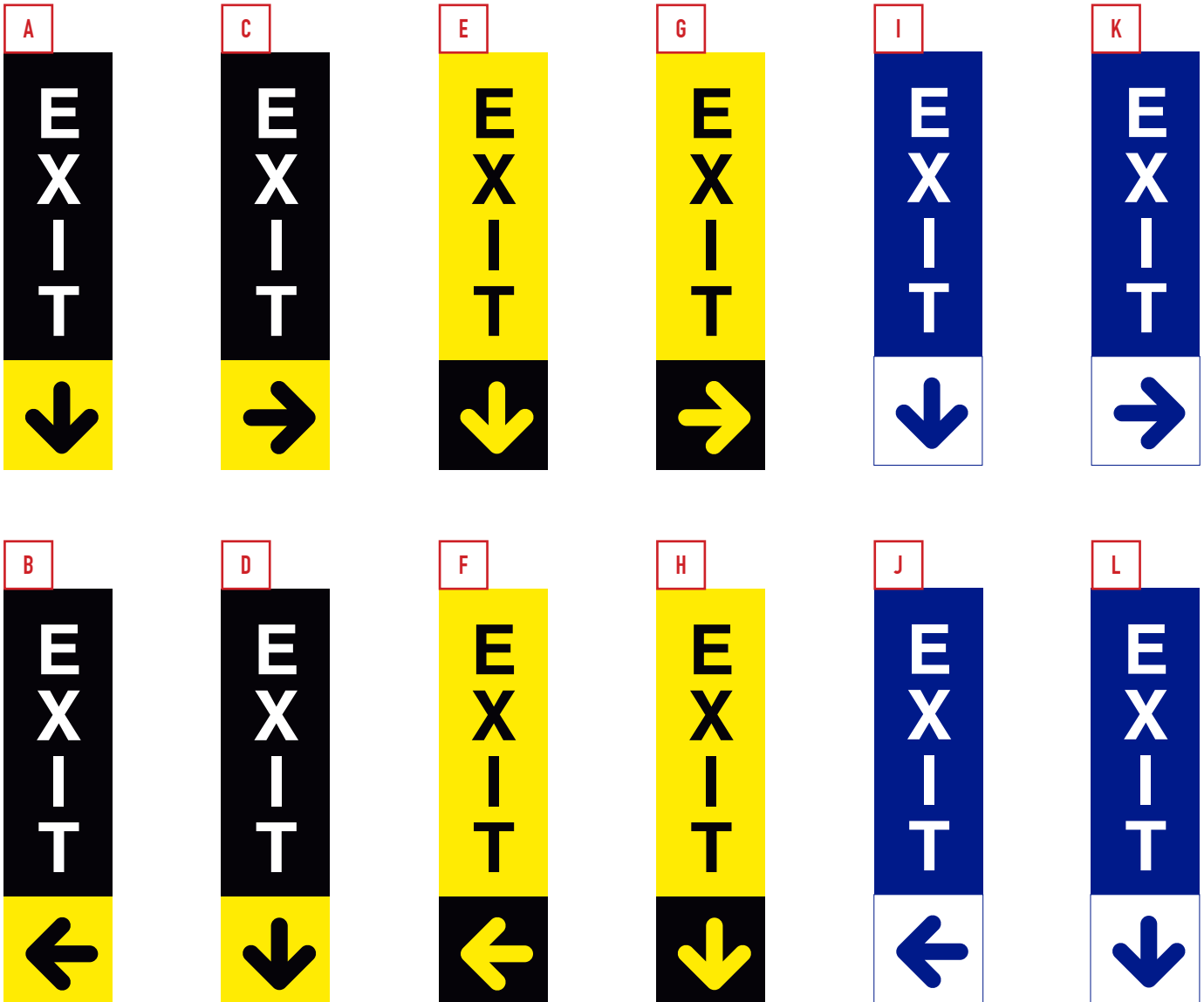

NOTE: ALL PREVIEWS SHOWN ARE NOT TO SCALE. ALL SIGN SIZES HAVE A HALF INCH ACCENT LINE AT BOTTOM

# EXIT SIGNS

## SIGN TYPE EX-103

Available in TWO sizes (H x W):

16" x 12"

24" x 18'

- Aluminum Fabricated Panel
- Baked Enamel Finish
- Available In 3 Colors

Choose arrow direction, colors, and text below, letters A thru R.

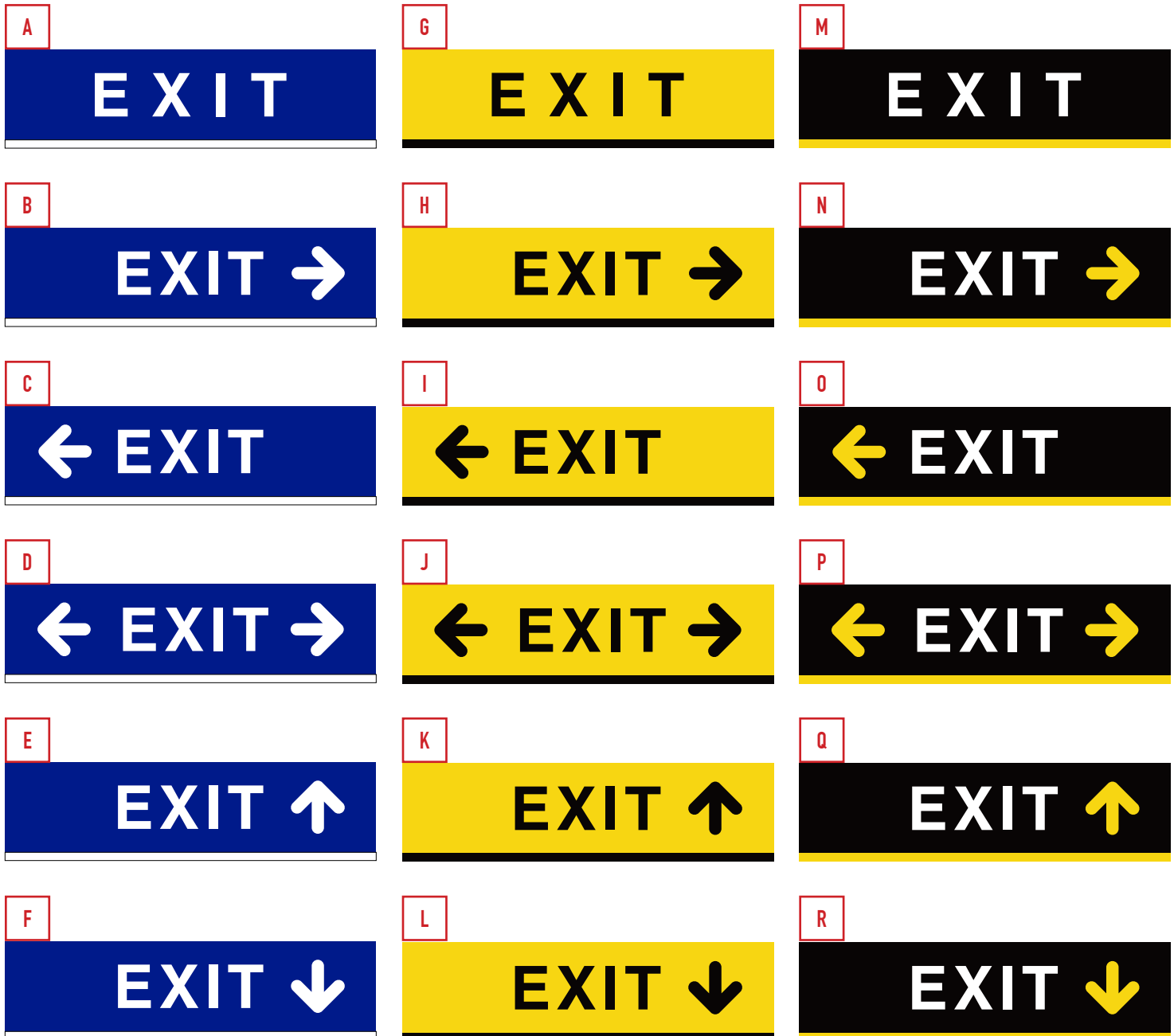

NOTE: ALL PREVIEWS SHOWN ARE NOT TO SCALE. ALL SIGN SIZES HAVE A HALF INCH ACCENT LINE AT BOTTOM

# EXIT SIGNS

## **SIGN TYPE EX-203**

Available in TWO sizes (H x W):

16" x 12"

24" x 18"

- Aluminum Fabricated Panel
- Baked Enamel Finish
- Available In 3 Colors

Choose arrow direction, colors, and text below, letters A thru L.



NOTE: ALL PREVIEWS SHOWN ARE NOT TO SCALE. ALL SIGN SIZES HAVE A HALF INCH ACCENT LINE AT BOTTOM

# EXIT SIGNS

## SIGN TYPE EX-104

- Aluminum Fabricated Panel
- Baked Enamel Finish
- Available In 3 Colors

Available in TWO sizes (H x W):  
16" x 12"  
24" x 18'

Choose arrow direction, colors, and text below, letters A thru L.



NOTE: ALL PREVIEWS SHOWN ARE NOT TO SCALE. ALL SIGN SIZES HAVE A HALF INCH ACCENT LINE AT BOTTOM



# EXIT SIGNS

## **SIGN TYPE EX-204**

Available in TWO sizes (H x W):

16" x 12"

24" x 18"

- Aluminum Fabricated Panel
- Baked Enamel Finish
- Available In 3 Colors

Choose arrow direction, colors, and text below, letters A thru L.



NOTE: ALL PREVIEWS SHOWN ARE NOT TO SCALE. ALL SIGN SIZES HAVE A HALF INCH ACCENT LINE AT BOTTOM

## **SIGN TYPE EX-105 + EX-106**

- Aluminum Fabricated Panel
- Baked Enamel Finish
- Available In 3 Colors

Available in THREE sizes (H x W):

8" x 32"

12" x 48"

18" x 72"

Choose arrow direction, colors, and text below, letters A thru C.

EX-105

A

**EXIT ONLY**

EX-205

A

**Exit Slowly**

B

**EXIT ONLY**

B

**Exit Slowly**

C

**EXIT ONLY**

C

**Exit Slowly**

NOTE: ALL PREVIEWS SHOWN ARE NOT TO SCALE. ALL SIGN SIZES HAVE A HALF INCH ACCENT LINE AT BOTTOM

# WAYFINDING SIGNS

## **SIGN TYPE WV-401**

- Aluminum Fabricated Panel
- Baked Enamel Finish
- Available In 3 Colors

Available in THREE sizes (H x W):

12"

18"

24"

Choose arrow direction, colors, and text below, letters A thru C.

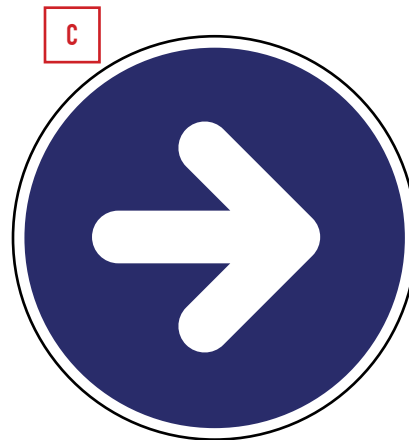
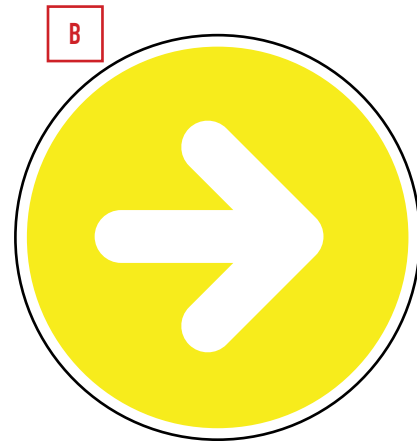
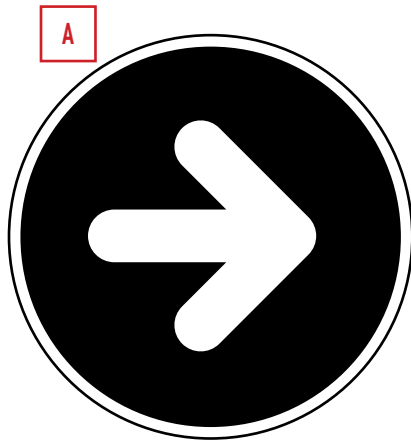

NOTE: ALL PREVIEWS SHOWN ARE NOT TO SCALE. ALL SIGN SIZES HAVE A HALF INCH ACCENT LINE AT BOTTOM

# WAYFINDING SIGNS

## **SIGN TYPE WV-101**

- Aluminum Fabricated Panel
- Baked Enamel Finish
- Available In 3 Colors

Available in THREE sizes (H x W):

8" x 32"

12" x 48"

18" x 72"

Choose arrow direction, colors, and text below, letters A thru F.



NOTE: ALL PREVIEWS SHOWN ARE NOT TO SCALE. ALL SIGN SIZES HAVE A HALF INCH ACCENT LINE AT BOTTOM



# WAYFINDING SIGNS

## **SIGN TYPE WV-201**

- Aluminum Fabricated Panel
- Baked Enamel Finish
- Available In 3 Colors

Available in TWO sizes (H x W):  
16" x 12"  
24" x 18"

Choose arrow direction, colors, and text below, letters A thru F.



NOTE: ALL PREVIEWS SHOWN ARE NOT TO SCALE. ALL SIGN SIZES HAVE A HALF INCH ACCENT LINE AT BOTTOM

# WAYFINDING SIGNS

## **SIGN TYPE WV-102**

- Aluminum Fabricated Panel
- Baked Enamel Finish
- Available In 3 Colors

Available in THREE sizes (H x W):  
8" x 32"  
12" x 48"  
18" x 72"

Choose arrow direction, colors, and text below, letters A thru L.

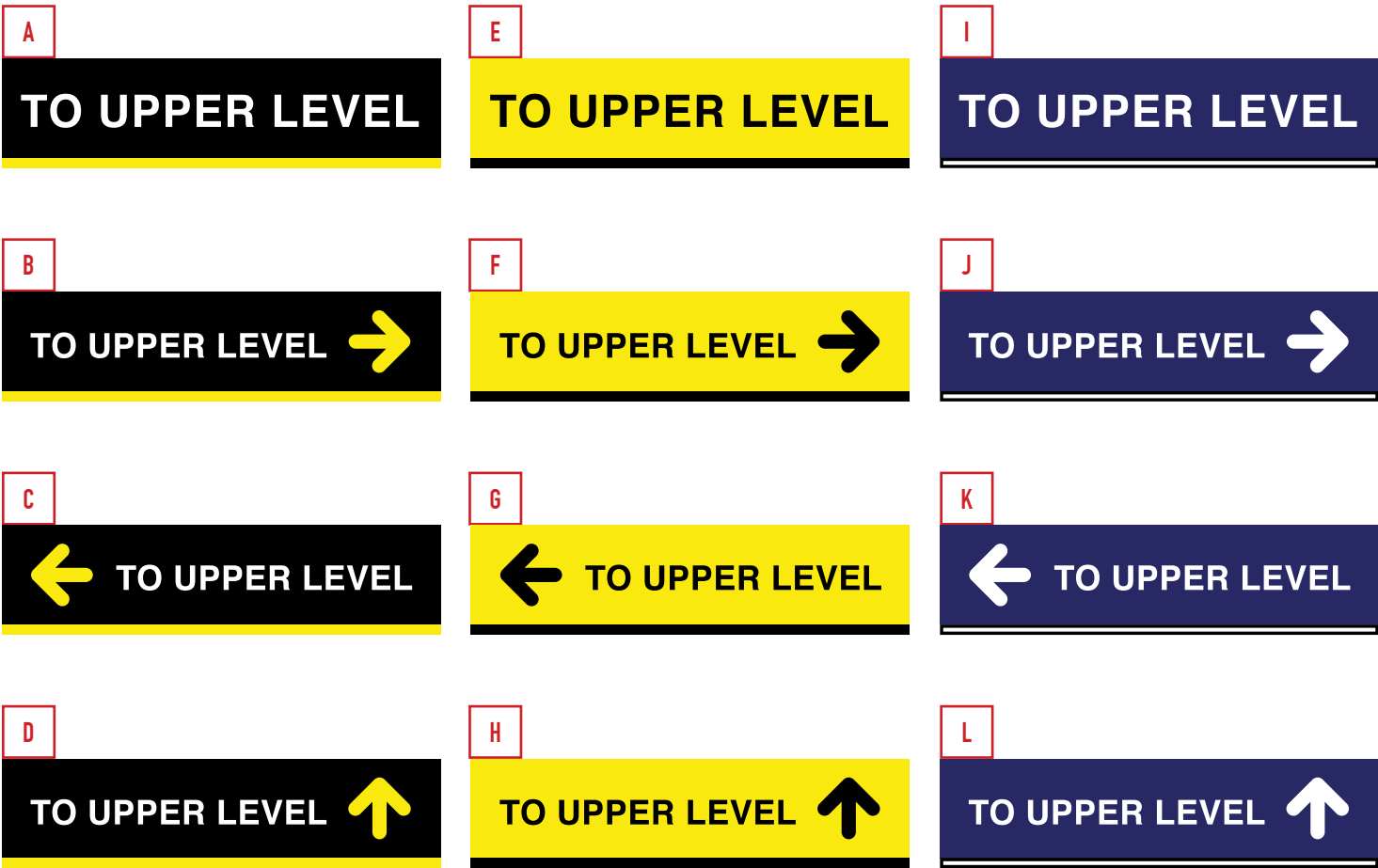

NOTE: ALL PREVIEWS SHOWN ARE NOT TO SCALE. ALL SIGN SIZES HAVE A HALF INCH ACCENT LINE AT BOTTOM



# WAYFINDING SIGNS

## **SIGN TYPE WV-202**

- Aluminum Fabricated Panel
- Baked Enamel Finish
- Available In 3 Colors

Available in TWO sizes (H x W):

16" x 12"

24" x 18"

Choose arrow direction, colors, and text below, letters A thru I.

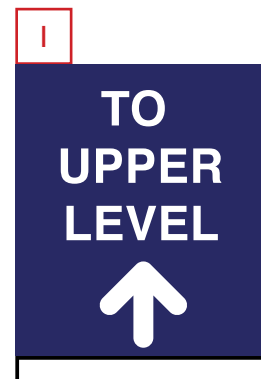
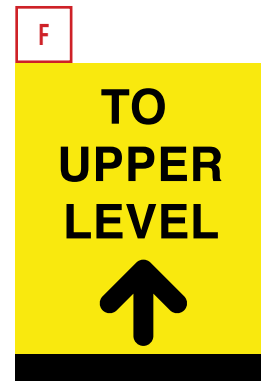

NOTE: ALL PREVIEWS SHOWN ARE NOT TO SCALE. ALL SIGN SIZES HAVE A HALF INCH ACCENT LINE AT BOTTOM

# WAYFINDING SIGNS

## **SIGN TYPE WV-103**

- Aluminum Fabricated Panel
- Baked Enamel Finish
- Available In 3 Colors

Available in THREE sizes (H x W):  
8" x 32"  
12" x 48"  
18" x 72"

Choose arrow direction, colors, and text below, letters A thru I.

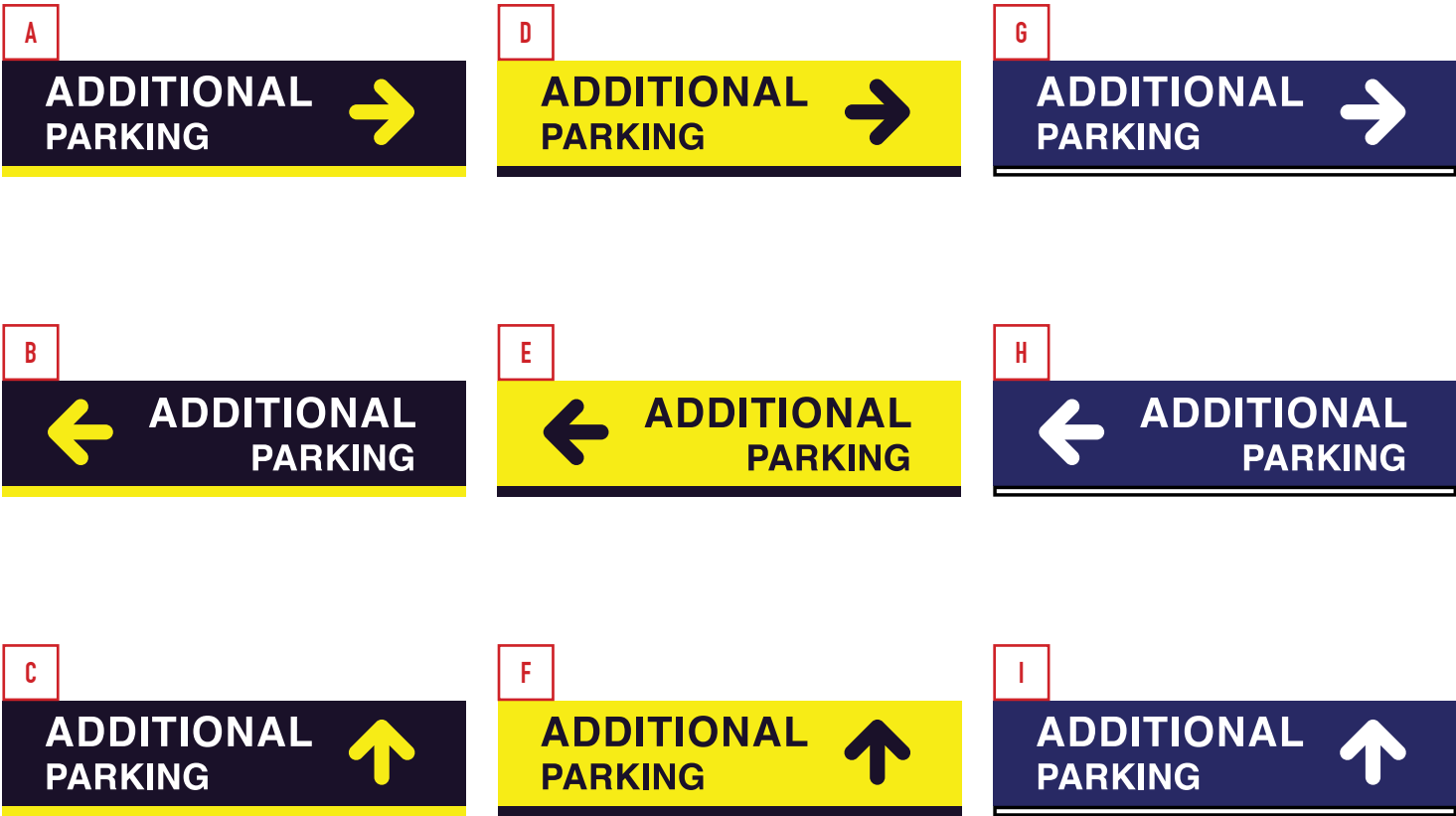

NOTE: ALL PREVIEWS SHOWN ARE NOT TO SCALE. ALL SIGN SIZES HAVE A HALF INCH ACCENT LINE AT BOTTOM





# WAYFINDING SIGNS

## **SIGN TYPE WV-203**

- Aluminum Fabricated Panel
- Baked Enamel Finish
- Available In 3 Colors

Available in TWO sizes (H x W):

12" x 16"

18" x 24"

Choose arrow direction, colors, and text below, letters A thru I.



NOTE: ALL PREVIEWS SHOWN ARE NOT TO SCALE. ALL SIGN SIZES HAVE A HALF INCH ACCENT LINE AT BOTTOM

# WAYFINDING SIGNS

## **SIGN TYPE WV-204**

- Aluminum Fabricated Panel
- Baked Enamel Finish
- Available In 3 Colors

Available in TWO sizes (H x W):  
16" x 12"  
24" x 18"

Choose arrow direction, colors, and text below, letters A thru I.

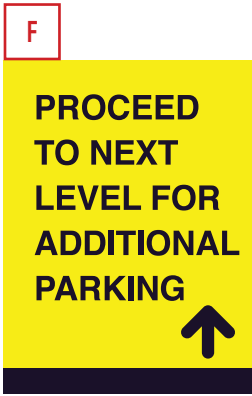
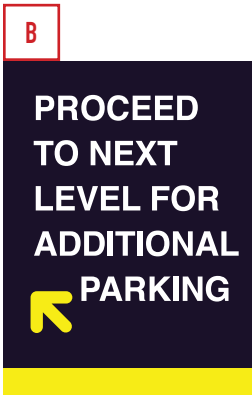
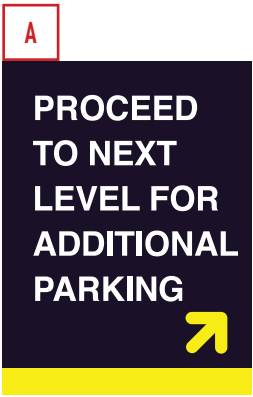

NOTE: ALL PREVIEWS SHOWN ARE NOT TO SCALE. ALL SIGN SIZES HAVE A HALF INCH ACCENT LINE AT BOTTOM



# WAYFINDING SIGNS

## **SIGN TYPE WV-105 + WV-106**

- Aluminum Fabricated Panel
- Baked Enamel Finish
- Available In 3 Colors

Available in THREE sizes (H x W):

8" x 32"

12" x 48"

18" x 72"

Choose arrow direction, colors, and text below, letters A thru C.

WV-105

A



B



C



WV-106

A



B



C



NOTE: ALL PREVIEWS SHOWN ARE NOT TO SCALE. ALL SIGN SIZES HAVE A HALF INCH ACCENT LINE AT BOTTOM

# WAYFINDING SIGNS

## SIGN TYPE WV-205+WV-206

- Aluminum Fabricated Panel
- Baked Enamel Finish
- Available In 3 Colors

Available in TWO sizes (H x W):  
16" x 12"  
24" x 18"

Choose arrow direction, colors, and text below, letters A thru C.

WV-205



WV-206



NOTE: ALL PREVIEWS SHOWN ARE NOT TO SCALE. ALL SIGN SIZES HAVE A HALF INCH ACCENT LINE AT BOTTOM



# REGULATORY+WARNING SIGNS

## **SIGN TYPE RI-101+RI-102**

- Aluminum Fabricated Panel
- Baked Enamel Finish
- Available In 3 Colors

Available in THREE sizes (H x W):

8" x 32"  
12" x 48"  
18" x 72"

Choose arrow direction, colors, and text below, letters A thru C.

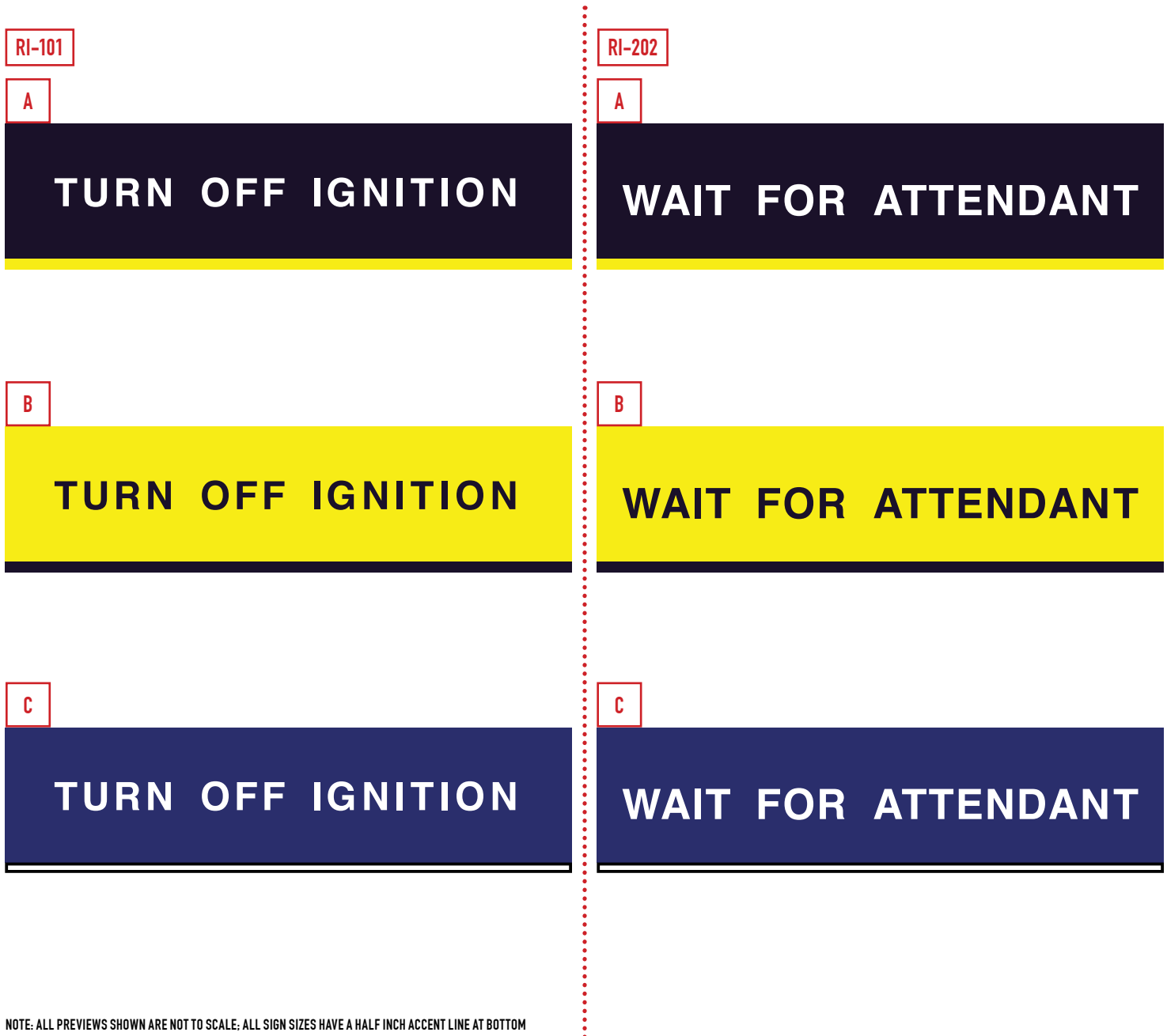

NOTE: ALL PREVIEWS SHOWN ARE NOT TO SCALE. ALL SIGN SIZES HAVE A HALF INCH ACCENT LINE AT BOTTOM

# REGULATORY+WARNING SIGNS

## SIGN TYPE RI-201+RI-202

- Aluminum Fabricated Panel
- Baked Enamel Finish
- Available In 3 Colors

Available in TWO sizes (H x W):

16" x 12"

24" x 18"

Choose arrow direction, colors, and text below, letters A thru C.

RI-201

A



B

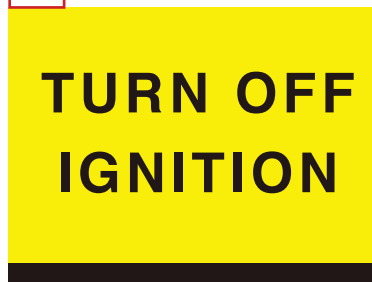

C



RI-202

A



B

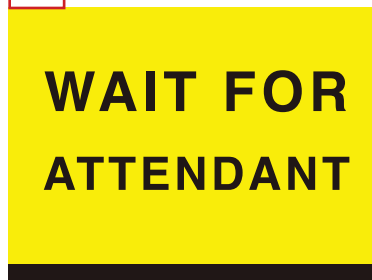

C



NOTE: ALL PREVIEWS SHOWN ARE NOT TO SCALE. ALL SIGN SIZES HAVE A HALF INCH ACCENT LINE AT BOTTOM

# REGULATORY+WARNING SIGNS

## **SIGN TYPE RI-103+RI-104**

Available in TWO sizes (H x W):

16" x 12"

24" x 18"

- Aluminum Fabricated Panel
- Baked Enamel Finish
- Available In 3 Colors

Choose arrow direction, colors, and text below, letters A thru C.



NOTE: ALL PREVIEWS SHOWN ARE NOT TO SCALE. ALL SIGN SIZES HAVE A HALF INCH ACCENT LINE AT BOTTOM

# REGULATORY+WARNING SIGNS

## SIGN TYPE RI-203+RI-204

- Aluminum Fabricated Panel
- Baked Enamel Finish
- Available In 3 Colors

Available in TWO sizes (H x W):

16" x 12"

24" x 18"

Choose arrow direction, colors, and text below, letters A thru C.

RI-203

A



B



C



RI-204

A



B



C



NOTE: ALL PREVIEWS SHOWN ARE NOT TO SCALE. ALL SIGN SIZES HAVE A HALF INCH ACCENT LINE AT BOTTOM



# REGULATORY+WARNING SIGNS

- Aluminum Fabricated Panel Available in TWO sizes (H x W):
- Baked Enamel Finish 16" x 12"
- Available In 3 Colors 24" x 18"

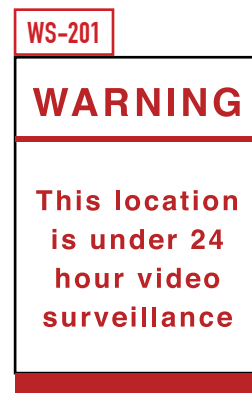

NOTE: ALL PREVIEWS SHOWN ARE NOT TO SCALE. ALL SIGN SIZES HAVE A HALF INCH ACCENT LINE AT BOTTOM

# REGULATORY+WARNING SIGNS

- Aluminum Fabricated Panel
- Baked Enamel Finish
- Available In 3 Colors

Available in TWO sizes (H x W):  
 16" x 12"  
 24" x 18'

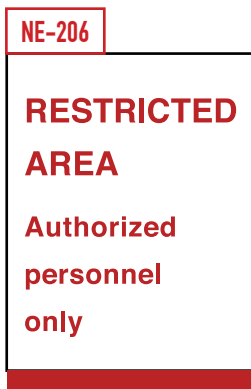
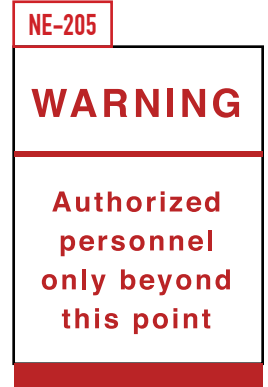

NOTE: ALL PREVIEWS SHOWN ARE NOT TO SCALE. ALL SIGN SIZES HAVE A HALF INCH ACCENT LINE AT BOTTOM



# REGULATORY+WARNING SIGNS

- Aluminum Fabricated Panel Available in TWO sizes (H x W):
- Baked Enamel Finish 16" x 12"
- Available In 3 Colors 24" x 18'



NOTE: ALL PREVIEWS SHOWN ARE NOT TO SCALE. ALL SIGN SIZES HAVE A HALF INCH ACCENT LINE AT BOTTOM

# REGULATORY+WARNING SIGNS

- Aluminum Fabricated Panel
- Baked Enamel Finish
- Available In 1 Color

Available in TWO sizes (H x W):  
16" x 12"  
24" x 18'

WR-303

**CAUTION  
ACTIVE  
DRIVEWAY**

WR-304

**CAUTION  
SPEED BUMP**

WR-307

**DO NOT  
BLOW HORN**

WR-208

**NO  
MOTORCYCLES  
PERMITTED**

WR-309

**NO  
PEDESTRIAN  
TRAFFIC**

WR-307

**FOR YOUR SAFETY  
USE  
HANDRAILS**

NP-303

**COMPACT  
CARS ONLY**

NOTE: ALL PREVIEWS SHOWN ARE NOT TO SCALE. ALL SIGN SIZES HAVE A HALF INCH ACCENT LINE AT BOTTOM

# REGULATORY+WARNING SIGNS

- Aluminum Fabricated Panel Available in TWO sizes (H x W):
- Baked Enamel Finish 16" x 12"
- Available In 1 Color 24" x 18"



Available in TWO sizes (H x W):  
6" x 16"  
9" x 24"



NOTE: ALL PREVIEWS SHOWN ARE NOT TO SCALE. ALL SIGN SIZES HAVE A HALF INCH ACCENT LINE AT BOTTOM

# REGULATORY + WARNING SIGNS

## **SIGN TYPE WR-102**

- Aluminum Fabricated Panel
- Baked Enamel Finish
- Available In 3 Colors

Available in THREE sizes (H x W):

8" x 32"

12" x 48"

18" x 72"

Choose arrow direction, colors, and text below, letters A thru C.



NOTE: ALL PREVIEWS SHOWN ARE NOT TO SCALE. ALL SIGN SIZES HAVE A HALF INCH ACCENT LINE AT BOTTOM

# REGULATORY+WARNING SIGNS

## **SIGN TYPE WR-202**

Available in TWO sizes (H x W):

12" x 18"

18" x 24"

- Aluminum Fabricated Panel
- Baked Enamel Finish
- Available In 3 Colors

Choose arrow direction, colors, and text below, letters A thru C.



NOTE: ALL PREVIEWS SHOWN ARE NOT TO SCALE. ALL SIGN SIZES HAVE A HALF INCH ACCENT LINE AT BOTTOM

# CLEARANCE SIGNS

## **SIGN TYPE CCL-101**

Available in ONE size (Diameter x W): 6" x 72"

Please provide the clearance height, feet and inches, when ordering your sign.  
Includes all mounting hardware.



## **SIGN TYPE CCL-102**

Available in ONE size (H x W): 6" x 96"

Please provide the clearance height, feet and inches, when ordering your sign.  
Includes all mounting hardware.



### INSTALLATION DETAILS

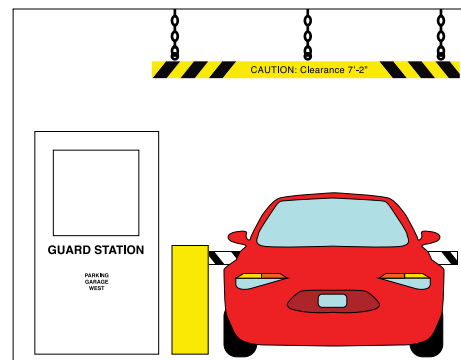
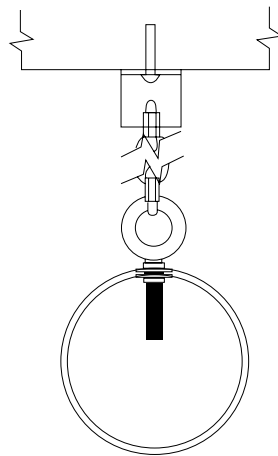

NOTE: ALL PREVIEWS SHOWN ARE NOT TO SCALE. ALL SIGN SIZES HAVE A HALF INCH ACCENT LINE AT BOTTOM



# INFORMATIONAL SIGNS

## **SIGN TYPE RI-106+RI-107**

- Aluminum Fabricated Panel
- Baked Enamel Finish
- Available In 3 Colors

Available in THREE sizes (H x W):

8" x 32"

12" x 48"

18" x 72"

Choose arrow direction, colors, and text below, letters A thru C.



NOTE: ALL PREVIEWS SHOWN ARE NOT TO SCALE. ALL SIGN SIZES HAVE A HALF INCH ACCENT LINE AT BOTTOM

# INFORMATIONAL SIGNS

## **SIGN TYPE RI-206+RI-207**

- Aluminum Fabricated Panel
- Baked Enamel Finish
- Available In 3 Colors

Available in TWO sizes (H x W):  
16" x 12"  
24" x 18'

Choose arrow direction, colors, and text below, letters A thru C.

RI-206

A

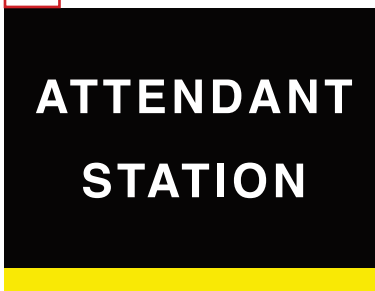

B

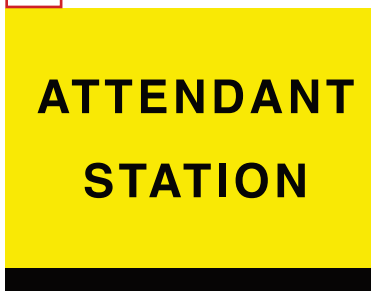

C



RI-207

A



B



C



NOTE: ALL PREVIEWS SHOWN ARE NOT TO SCALE. ALL SIGN SIZES HAVE A HALF INCH ACCENT LINE AT BOTTOM

# INFORMATIONAL SIGNS

## **SIGN TYPE OH-203**

Available in TWO sizes (H x W):

16" x 12"

24" x 18"

- Aluminum Fabricated Panel
- Baked Enamel Finish
- Available In 3 Colors

Choose arrow direction, colors, and text below, letters A thru L.

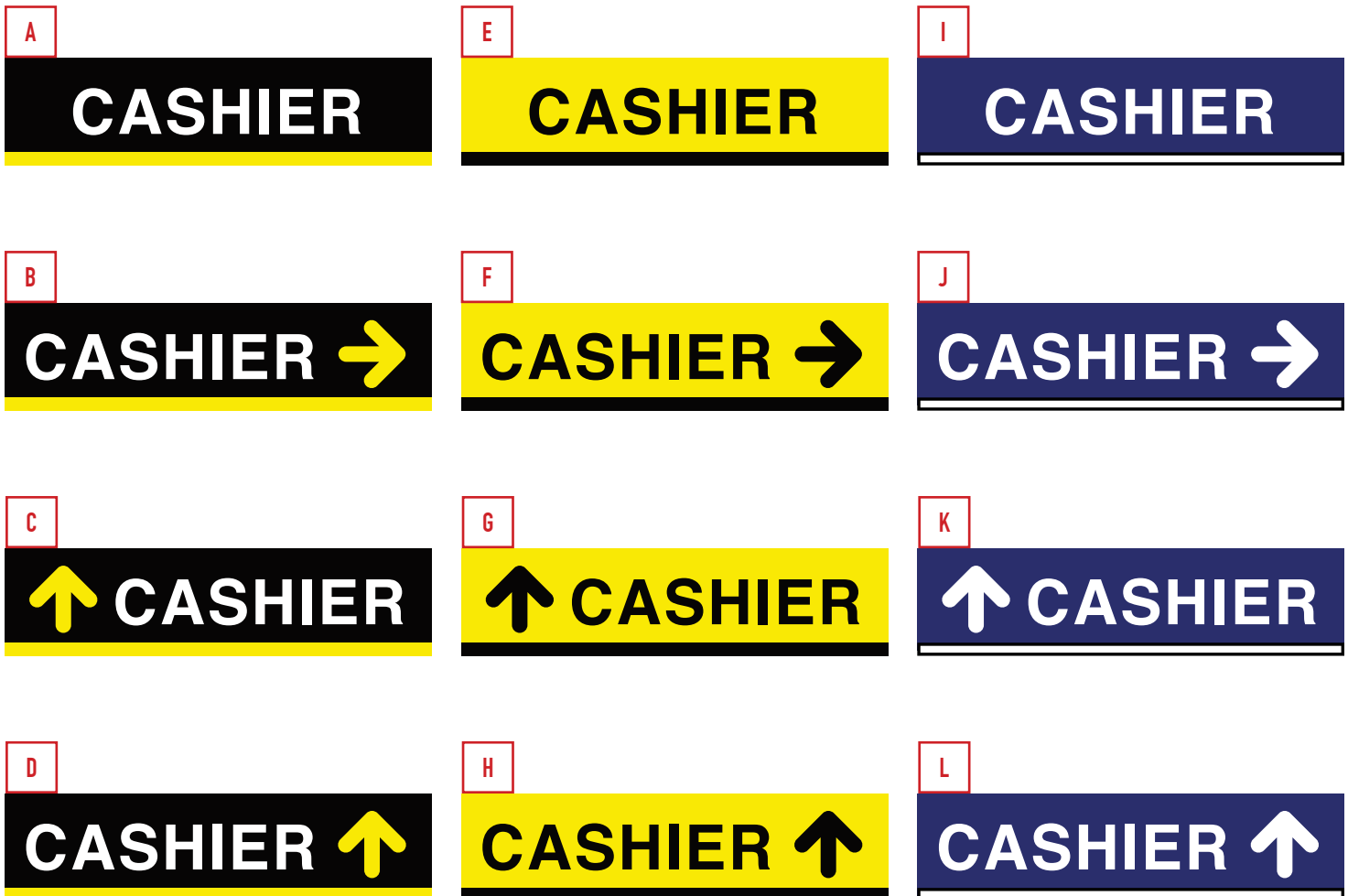

NOTE: ALL PREVIEWS SHOWN ARE NOT TO SCALE. ALL SIGN SIZES HAVE A HALF INCH ACCENT LINE AT BOTTOM

# INFORMATIONAL SIGNS

## SIGN TYPE RI-205

- Aluminum Fabricated Panel
- Baked Enamel Finish
- Available In 3 Colors

Available in TWO sizes (H x W):  
12" x 16"  
18" x 24"

Choose arrow direction, colors, and text below, letters A thru L.

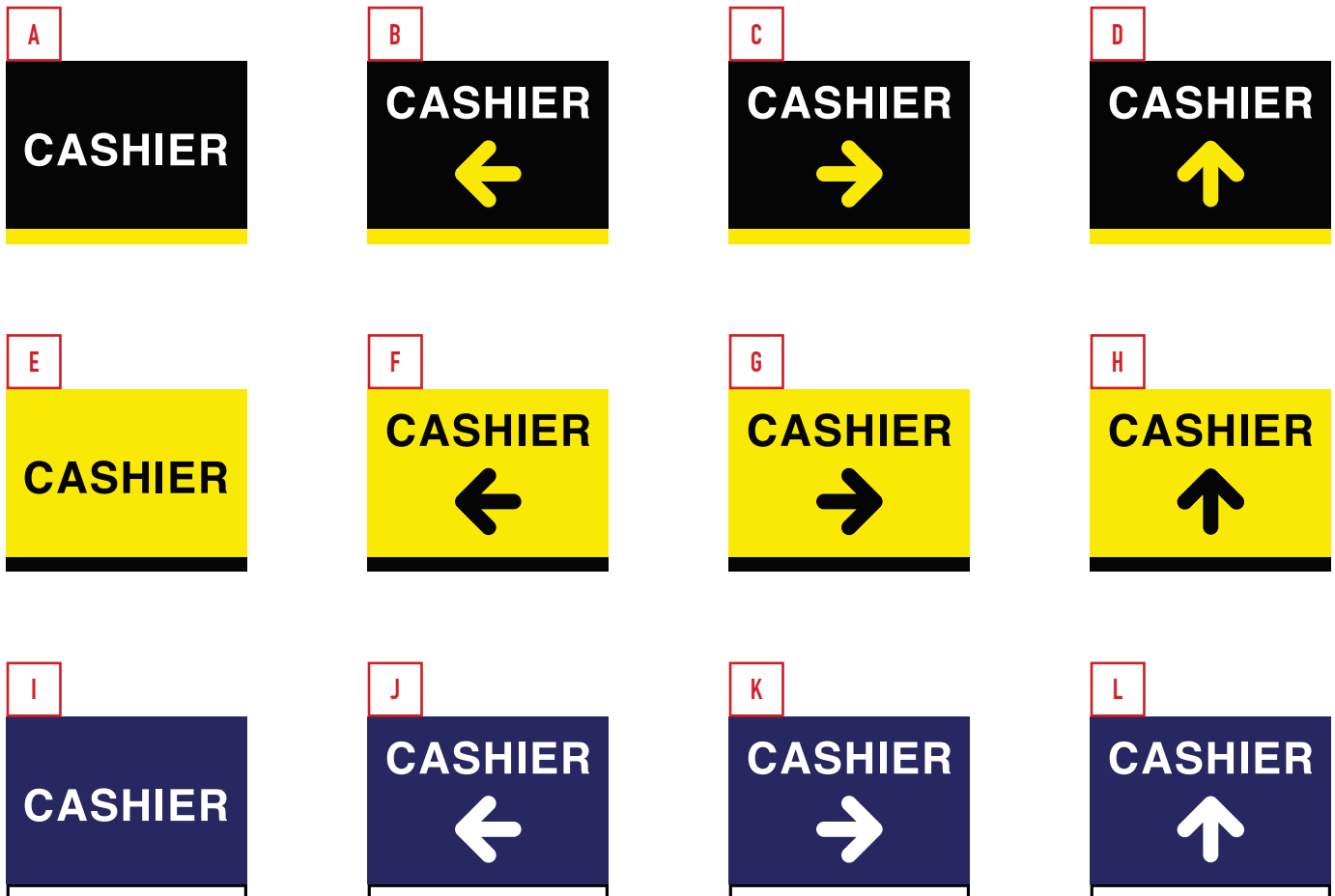

NOTE: ALL PREVIEWS SHOWN ARE NOT TO SCALE. ALL SIGN SIZES HAVE A HALF INCH ACCENT LINE AT BOTTOM

# INFORMATIONAL SIGNS

## **SIGN TYPE MI-203**

- Aluminum Fabricated Panel
- Baked Enamel Finish
- Available In 3 Colors

Available in TWO sizes (H x W):  
8" x 6"  
16" x 12"

Choose arrow direction, colors, and text below, letters A thru C.



NOTE: ALL PREVIEWS SHOWN ARE NOT TO SCALE. ALL SIGN SIZES HAVE A HALF INCH ACCENT LINE AT BOTTOM

# INFORMATIONAL SIGNS

## **SIGN TYPE RI-308**

- Aluminum Fabricated Panel
- Baked Enamel Finish
- Available In 3 Colors

Available in TWO sizes (H x W):  
16" x 12"  
24" x 18'

Choose arrow direction, colors, and text below, letters A thru F.



NOTE: ALL PREVIEWS SHOWN ARE NOT TO SCALE. ALL SIGN SIZES HAVE A HALF INCH ACCENT LINE AT BOTTOM

# INFORMATIONAL SIGNS

## **SIGN TYPE RG-201**

Available in TWO sizes (H x W):

16" x 12"

24" x 18'

- Aluminum Fabricated Panel
- Baked Enamel Finish
- Available In 3 Colors

Choose arrow direction, colors, and text below, letters A thru F.

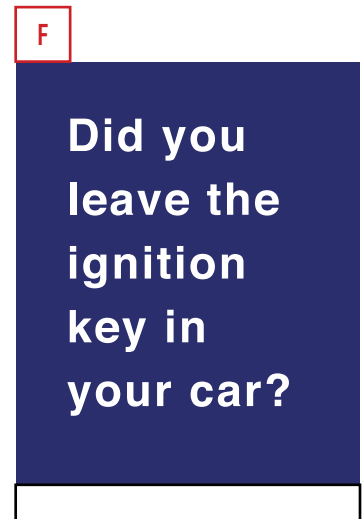
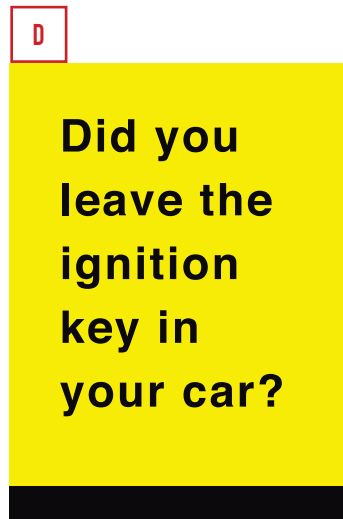
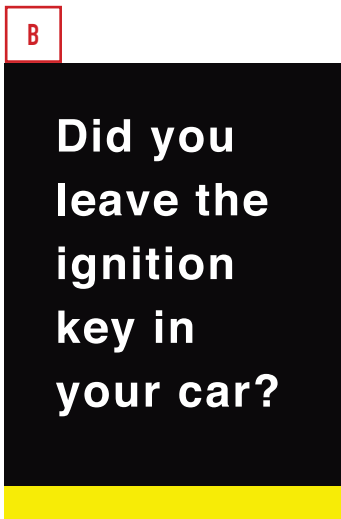
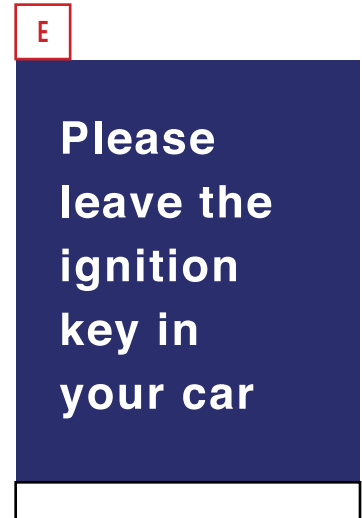
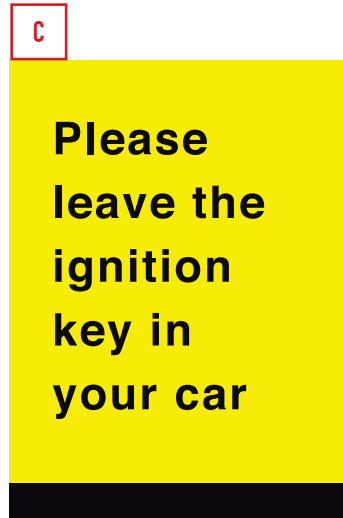
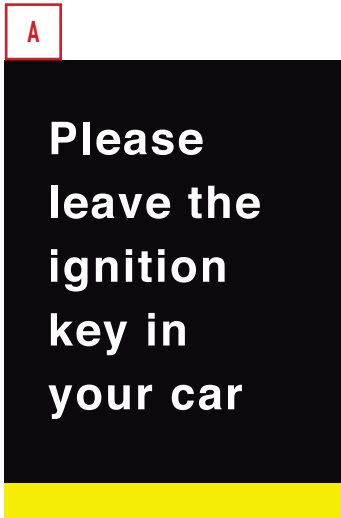

NOTE: ALL PREVIEWS SHOWN ARE NOT TO SCALE. ALL SIGN SIZES HAVE A HALF INCH ACCENT LINE AT BOTTOM

# INFORMATIONAL SIGNS

## **SIGN TYPE RG-202**

- Aluminum Fabricated Panel
- Baked Enamel Finish
- Available In 3 Colors

Available in TWO sizes (H x W):

16" x 12"

24" x 18"

Choose arrow direction, colors, and text below, letters A thru C.

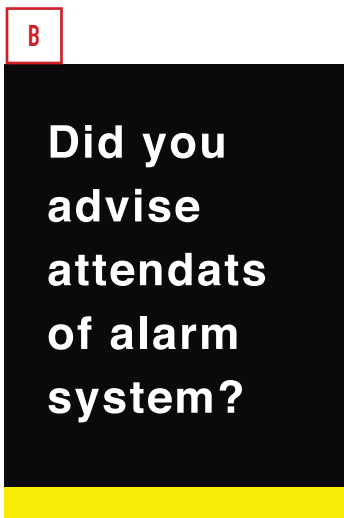
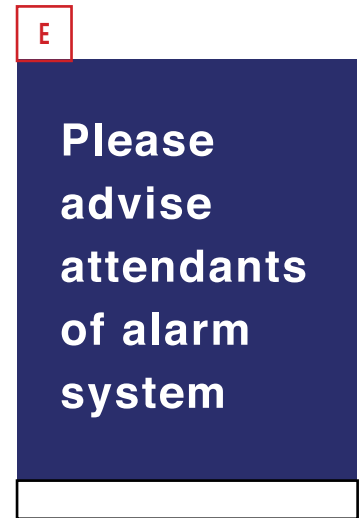
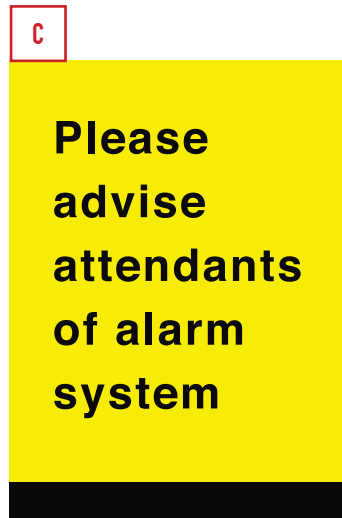
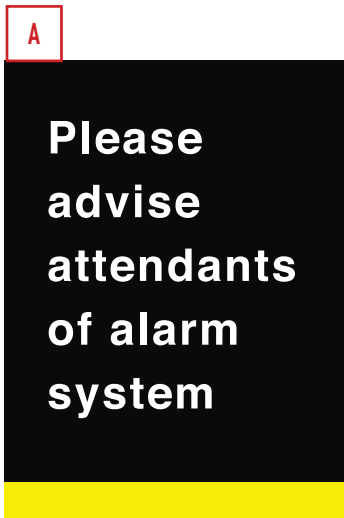

NOTE: ALL PREVIEWS SHOWN ARE NOT TO SCALE. ALL SIGN SIZES HAVE A HALF INCH ACCENT LINE AT BOTTOM



# INFORMATIONAL SIGNS

## **SIGN TYPE RG-203+RG-204**

- Aluminum Fabricated Panel
- Baked Enamel Finish
- Available In 3 Colors

Available in TWO sizes (H x W):

16" x 12"

24" x 18'

Choose arrow direction, colors, and text below, letters A thru C.

RG-203

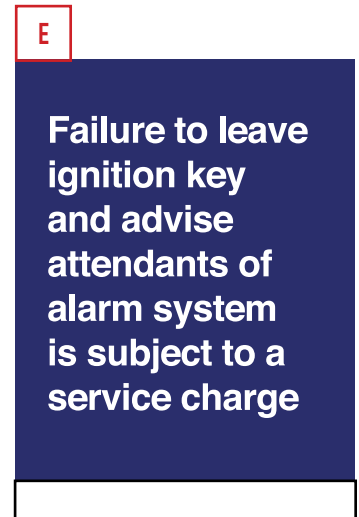
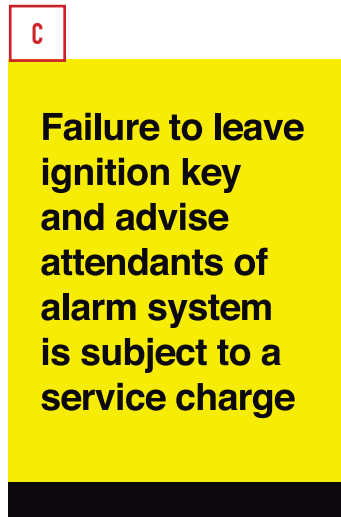
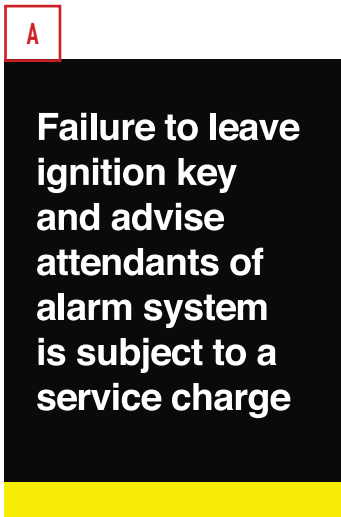

RG-204

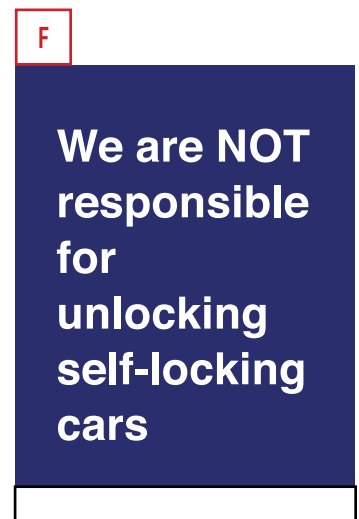
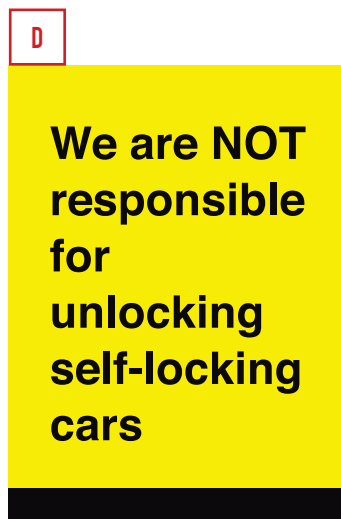
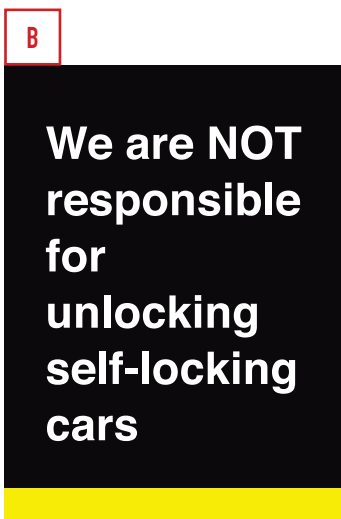

NOTE: ALL PREVIEWS SHOWN ARE NOT TO SCALE. ALL SIGN SIZES HAVE A HALF INCH ACCENT LINE AT BOTTOM

# INFORMATIONAL SIGNS

## **SIGN TYPE RG-205+RG-206**

- Aluminum Fabricated Panel
- Baked Enamel Finish
- Available In 3 Colors

Available in TWO sizes (H x W):

16" x 12"

24" x 18'

Choose arrow direction, colors, and text below, letters A thru C.

RG-205

A

**We are NOT  
responsible  
for any  
personal  
articles left  
in your car**

B

**We are NOT  
responsible  
for any  
personal  
articles left  
in your car**

C

**We are NOT  
responsible  
for any  
personal  
articles left  
in your car**

RG-206

A

**We are NOT  
responsible  
for damage  
on painted,  
rubber or  
plastic  
bumpers**

B

**We are NOT  
responsible  
for damage  
on painted,  
rubber or  
plastic  
bumpers**

C

**We are NOT  
responsible  
for damage  
on painted,  
rubber or  
plastic  
bumpers**

NOTE: ALL PREVIEWS SHOWN ARE NOT TO SCALE. ALL SIGN SIZES HAVE A HALF INCH ACCENT LINE AT BOTTOM

# INFORMATIONAL SIGNS

## **SIGN TYPE RG-207+RG-208**

- Aluminum Fabricated Panel
- Baked Enamel Finish
- Available In 3 Colors

Available in TWO sizes (H x W):  
16" x 12"  
24" x 18'

Choose arrow direction, colors, and text below, letters A thru C.

RG-207

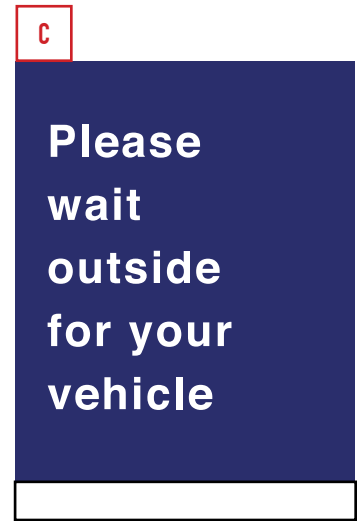
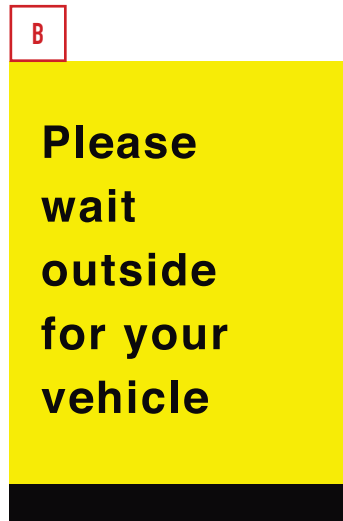

RG-208

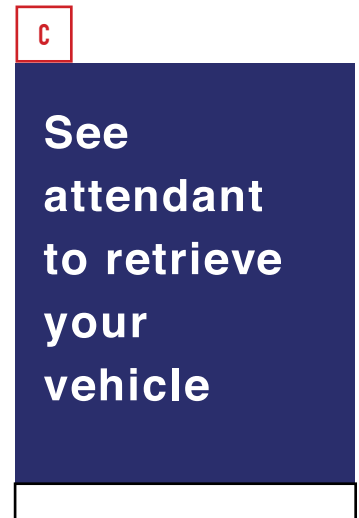
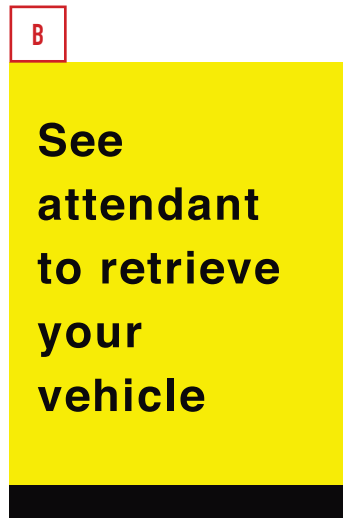
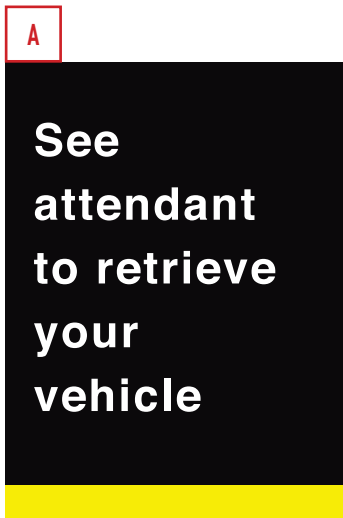

NOTE: ALL PREVIEWS SHOWN ARE NOT TO SCALE. ALL SIGN SIZES HAVE A HALF INCH ACCENT LINE AT BOTTOM

# INFORMATIONAL SIGNS

## SIGN TYPE RM-201+RM-202

- Aluminum Fabricated Panel
- Baked Enamel Finish
- Available In 3 Colors

Available in TWO sizes (H x W):

16" x 12"

24" x 18'

Choose arrow direction, colors, and text below, letters A thru C.

RM-201

A

**Monthly  
space  
available,  
inquire  
within**

C

**Monthly  
space  
available,  
inquire  
within**

E

**Monthly  
space  
available,  
inquire  
within**

RM-202

A

**Motorcycle  
space  
available,  
inquire  
within**

B

**Motorcycle  
space  
available,  
inquire  
within**

C

**Motorcycle  
space  
available,  
inquire  
within**

NOTE: ALL PREVIEWS SHOWN ARE NOT TO SCALE. ALL SIGN SIZES HAVE A HALF INCH ACCENT LINE AT BOTTOM

# INFORMATIONAL SIGNS

## **SIGN TYPE RM-301+RM-305**

- Aluminum Fabricated Panel
- Baked Enamel Finish
- Available In 3 Colors

Available in TWO sizes (H x W):

16" x 12"

24" x 18'

Choose arrow direction, colors, and text below, letters A thru C.

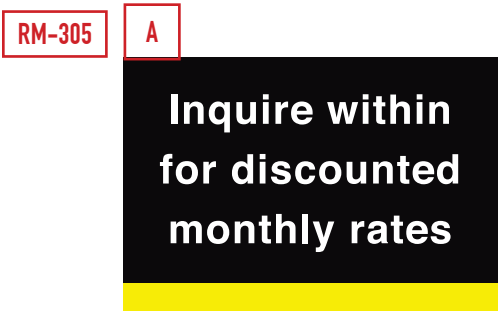
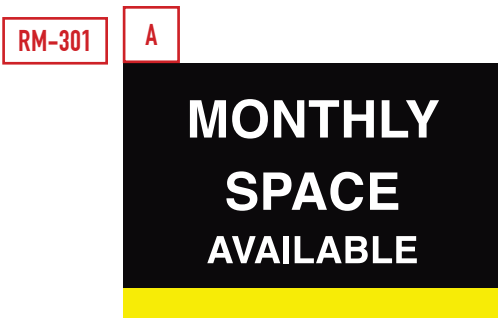

NOTE: ALL PREVIEWS SHOWN ARE NOT TO SCALE. ALL SIGN SIZES HAVE A HALF INCH ACCENT LINE AT BOTTOM

# INFORMATIONAL SIGNS

## SIGN TYPE RM-203

- Aluminum Fabricated Panel
- Baked Enamel Finish
- Available In 3 Colors

Available in TWO sizes (H x W):

16" x 12"

24" x 18"

Choose arrow direction, colors, and text below, letters A thru F.

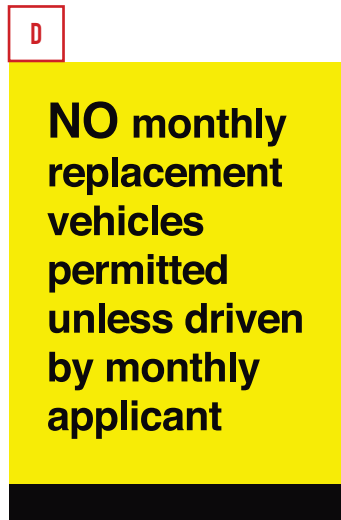

NOTE: ALL PREVIEWS SHOWN ARE NOT TO SCALE. ALL SIGN SIZES HAVE A HALF INCH ACCENT LINE AT BOTTOM

# INFORMATIONAL SIGNS

## **SIGN TYPE RM-204**

- Aluminum Fabricated Panel
- Baked Enamel Finish
- Available In 3 Colors

Available in TWO sizes (H x W):

16" x 12"

24" x 18"

Choose arrow direction, colors, and text below, letters A thru C.

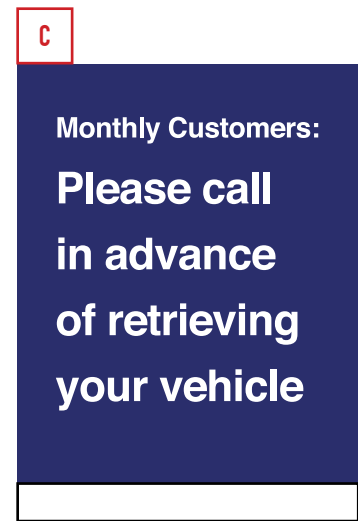
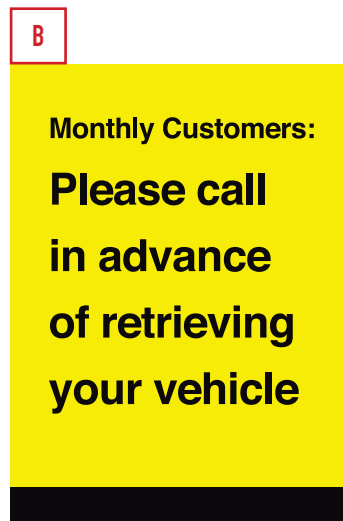

NOTE: ALL PREVIEWS SHOWN ARE NOT TO SCALE. ALL SIGN SIZES HAVE A HALF INCH ACCENT LINE AT BOTTOM

# CHANGEABLE OUTDOOR+INDOOR SIGNS

## **SIGN TYPE S-MF-205C**

Available in ONE size (H x W): 44"x28"

Freestanding

Outdoor and Indoor use

Double-sided and features snap-open frame for interchangeable sign panel. The molded base is equipped with two built-in wheels that engage to easily roll when sign is tilted, but disengage when sign is in the upright position. Base can be weighted with liquid or sand. Curb sign is made in the U.S.A



NOTE: ALL PREVIEWS SHOWN ARE NOT TO SCALE. ALL SIGN SIZES HAVE A HALF INCH ACCENT LINE AT BOTTOM





# CHANGEABLE OUTDOOR+INDOOR SIGNS

## **SIGN TYPE L-MF-205C**

Freestanding and features sliding sign panel from the top

Indoor use: 12" x 16"; Double-sided

Outdoor use: 18" x 24"; Double-sided

These panels are changeable. Provide your own text using page 123.



NOTE: ALL PREVIEWS SHOWN ARE NOT TO SCALE. ALL SIGN SIZES HAVE A HALF INCH ACCENT LINE AT BOTTOM

# LEVEL+AILSE MARKERS

## **SIGN TYPE LA-201**

Available in ONE size (H x W):  
16" x 12"

- Aluminum Fabricated Panel
- Baked Enamel Finish
- Available In 6 Colors

Choose arrow direction, colors, and text below, letters A thru C.



NOTE: ALL PREVIEWS SHOWN ARE NOT TO SCALE. ALL SIGN SIZES HAVE A HALF INCH ACCENT LINE AT BOTTOM

# LEVEL+AISLE MARKERS

## SIGN TYPE LA-202

Available in ONE size (H x W):  
16" x 12"

- Aluminum Fabricated Panel
- Baked Enamel Finish
- Available In 6 Colors

Choose arrow direction, colors, and text below, letters A thru C.

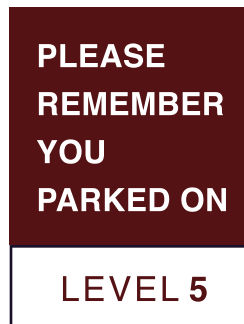
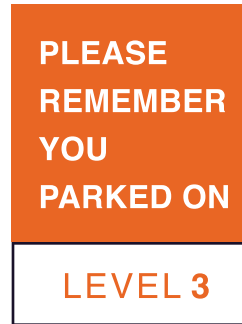
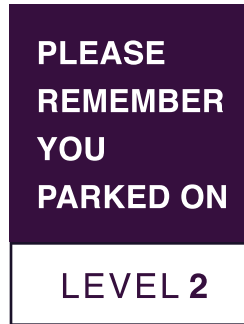

NOTE: ALL PREVIEWS SHOWN ARE NOT TO SCALE. ALL SIGN SIZES HAVE A HALF INCH ACCENT LINE AT BOTTOM

# LEVEL+AILSE MARKERS

## SIGN TYPE LA-302

Available in ONE size (H x W):  
16" x 12"

- Aluminum Fabricated Panel
- Baked Enamel Finish
- Available In 6 Colors

Choose arrow direction, colors, and text below, letters A thru F.

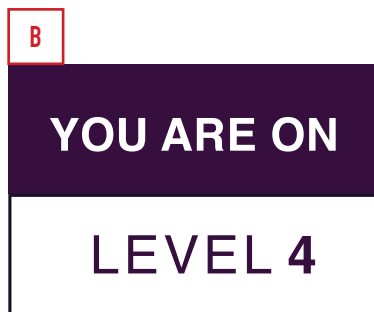

NOTE: ALL PREVIEWS SHOWN ARE NOT TO SCALE. ALL SIGN SIZES HAVE A HALF INCH ACCENT LINE AT BOTTOM

# LEVEL+AISLE MARKERS

## **SIGN TYPE C-LA-203**

Available in ONE size (H x W):  
16" x 12"

- Aluminum Fabricated Panel
- Baked Enamel Finish
- Available In 3 Colors

Choose arrow direction, colors, and text below, letters A thru F.  
Please specify aisle numbers when ordering your signs.



NOTE: ALL PREVIEWS SHOWN ARE NOT TO SCALE. ALL SIGN SIZES HAVE A HALF INCH ACCENT LINE AT BOTTOM

# LEVEL+AISLE MARKERS

## **SIGN TYPE C-LA-204** Available in ONE size (H x W): 16" x 12"

- Aluminum Fabricated Panel
- Baked Enamel Finish
- Available In 6 Colors

Choose arrow direction, colors, and text below, letters A thru F.  
Please specify aisle and floor numbers when ordering your signs.



NOTE: ALL PREVIEWS SHOWN ARE NOT TO SCALE. ALL SIGN SIZES HAVE A HALF INCH ACCENT LINE AT BOTTOM

# STAIR+ELEVATOR SIGNS

## **SIGN TYPE SE-201**

Available in ONE size (H x W):  
16" x 12"

- Aluminum Fabricated Panel
- Baked Enamel Finish
- Available In 6 Colors

Choose stair letter and color below and on page 90.

Choose arrow direction, colors, and text below, letters A thru F.

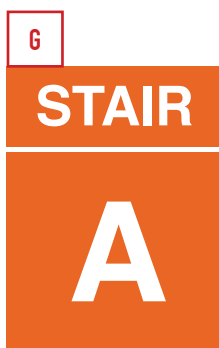
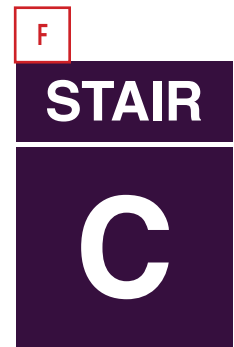
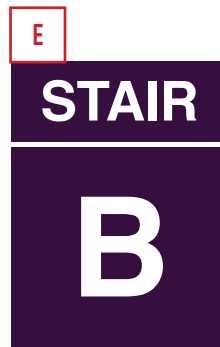
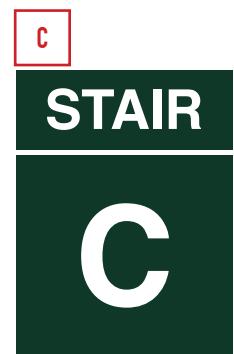

NOTE: ALL PREVIEWS SHOWN ARE NOT TO SCALE. ALL SIGN SIZES HAVE A HALF INCH ACCENT LINE AT BOTTOM

# STAIR+ELEVATOR SIGNS

## SIGN TYPE SE-201

CONTINUED.

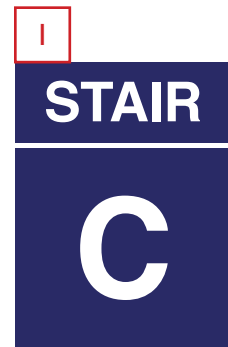
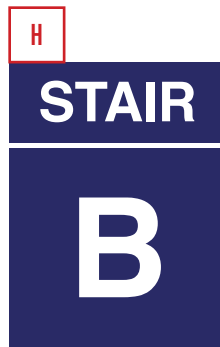
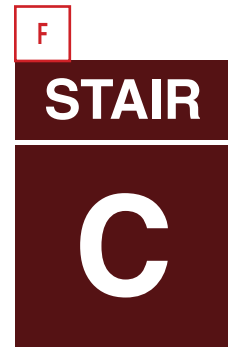

NOTE: ALL PREVIEWS SHOWN ARE NOT TO SCALE. ALL SIGN SIZES HAVE A HALF INCH ACCENT LINE AT BOTTOM



# STAIR+ELEVATOR SIGNS

## SIGN TYPE SE-203

- Aluminum Fabricated Panel
- Baked Enamel Finish
- Available In 6 Colors

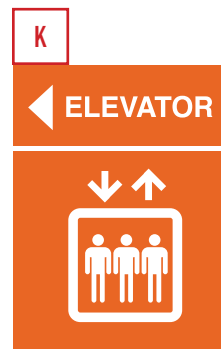

NOTE: ALL PREVIEWS SHOWN ARE NOT TO SCALE. ALL SIGN SIZES HAVE A HALF INCH ACCENT LINE AT BOTTOM

# STAIR+ELEVATOR SIGNS

## **SIGN TYPE SE-203**

CONTINUED.



NOTE: ALL PREVIEWS SHOWN ARE NOT TO SCALE. ALL SIGN SIZES HAVE A HALF INCH ACCENT LINE AT BOTTOM

# STAIR+ELEVATOR SIGNS

## **SIGN TYPE C-FE-501**

- Aluminum Fabricated Panel
- Baked Enamel Finish
- Available In 6 Colors

Available in ONE size (H x W):  
12" x 12"

Choose colors and text below, letters A thru F.

Please provide your exact sign text and map when ordering your sign (use page 123)

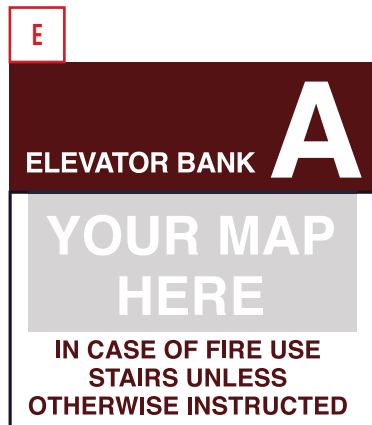
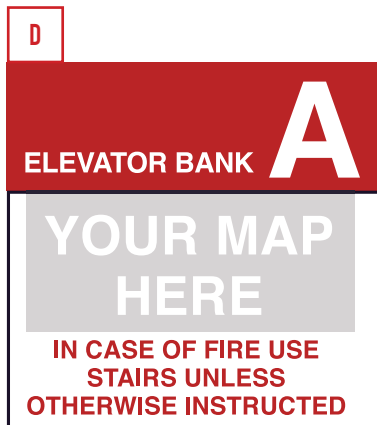
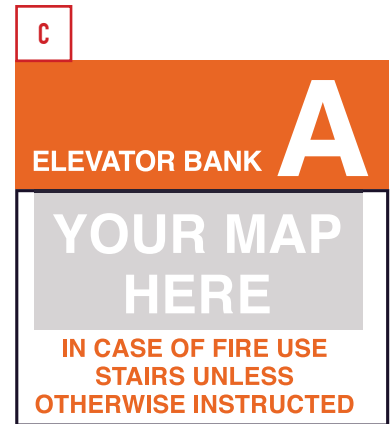
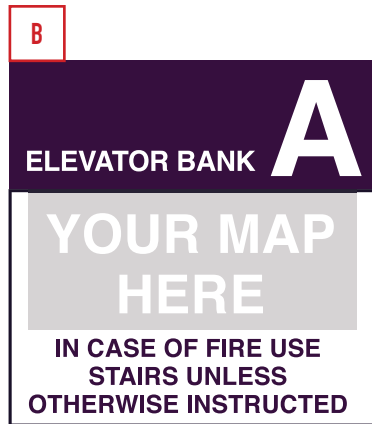
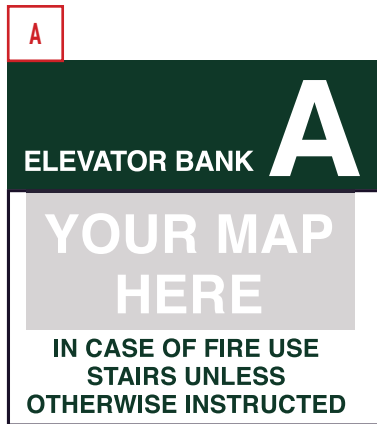

NOTE: ALL PREVIEWS SHOWN ARE NOT TO SCALE. ALL SIGN SIZES HAVE A HALF INCH ACCENT LINE AT BOTTOM

# ADA COMPLIANT SIGNS

## **SIGN TYPE A-EX-204**

- ADA compliant with Grade II Braille and tactile letters
- Zinc for outdoor and indoor use.
- Available In 3 Colors

Available in ONE size (H x W):  
8" x 6"

Choose colors and text below, letters A thru C.



NOTE: ALL PREVIEWS SHOWN ARE NOT TO SCALE. ALL SIGN SIZES HAVE A HALF INCH ACCENT LINE AT BOTTOM

# ADA COMPLIANT SIGNS

## SIGN TYPE A-MI-201

Available in ONE size (H x W):  
8" x 6"

- ADA compliant with Grade II Braille and tactile letters
- Zinc for outdoor and indoor use.
- Available In 3 Colors

Choose symbol, colors, and text below, letters A thru F.



NOTE: ALL PREVIEWS SHOWN ARE NOT TO SCALE. ALL SIGN SIZES HAVE A HALF INCH ACCENT LINE AT BOTTOM

# ADA COMPLIANT SIGNS

## SIGN TYPE A-MI-202

- ADA compliant with Grade II Braille and tactile letters
- Zinc for outdoor and indoor use.
- Available In 3 Colors

Available in ONE size (H x W):  
8"x 6"

Choose symbol, colors, and text below, letters A thru F.



NOTE: ALL PREVIEWS SHOWN ARE NOT TO SCALE. ALL SIGN SIZES HAVE A HALF INCH ACCENT LINE AT BOTTOM

# ADA COMPLIANT SIGNS

## **SIGN TYPE A-LA-201**

Available in ONE size (H x W):  
8" x 6"

- ADA compliant with Grade II Braille and tactile letters
- Zinc for outdoor and indoor use.
- Available In 3 Colors

Choose symbol, colors, and text below, letters A thru F.



NOTE: ALL PREVIEWS SHOWN ARE NOT TO SCALE. ALL SIGN SIZES HAVE A HALF INCH ACCENT LINE AT BOTTOM

# ADA COMPLIANT SIGNS

## SIGN TYPE A-SE-201

- ADA compliant with Grade II Braille and tactile letters
- Zinc for outdoor and indoor use.
- Available In 6 Colors

Available in ONE size (H x W):  
8" x 6"

Choose stair letter and color below and on page 97.  
Letters A thru R.

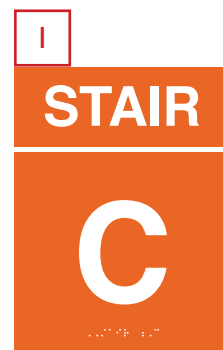
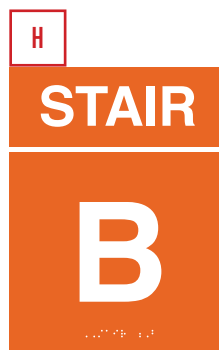
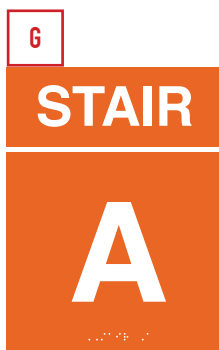
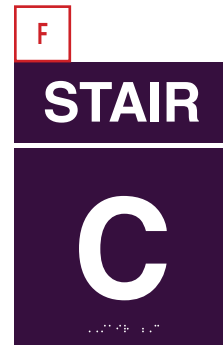
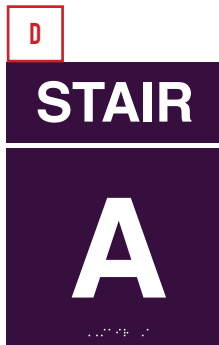
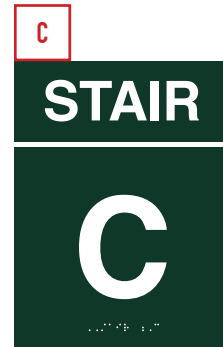

NOTE: ALL PREVIEWS SHOWN ARE NOT TO SCALE. ALL SIGN SIZES HAVE A HALF INCH ACCENT LINE AT BOTTOM





# ADA COMPLIANT SIGNS

## **SIGN TYPE A-SE-201**

CONTINUED.

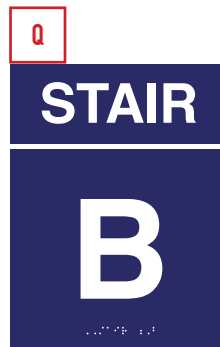

NOTE: ALL PREVIEWS SHOWN ARE NOT TO SCALE. ALL SIGN SIZES HAVE A HALF INCH ACCENT LINE AT BOTTOM

# ADA COMPLIANT SIGNS

## SIGN TYPE A-SE-202

- ADA compliant with Grade II Braille and tactile letters
- Zinc for outdoor and indoor use.
- Available In 6 Colors

Available in ONE size (H x W):  
8"x 6"

Choose stair letter and color below and on page 101.

Letters A thru R.

Please specify stair and level number when ordering your sign.

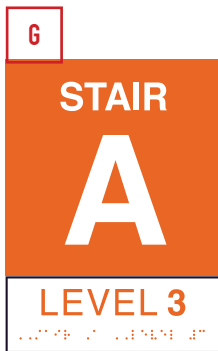
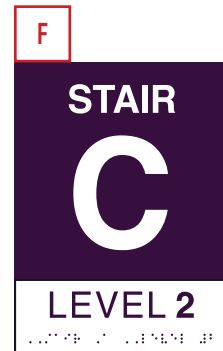

NOTE: ALL PREVIEWS SHOWN ARE NOT TO SCALE. ALL SIGN SIZES HAVE A HALF INCH ACCENT LINE AT BOTTOM



# ADA COMPLIANT SIGNS

## **SIGN TYPE A-SE-202**

CONTINUED.

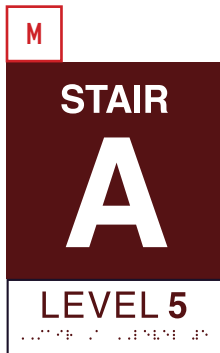
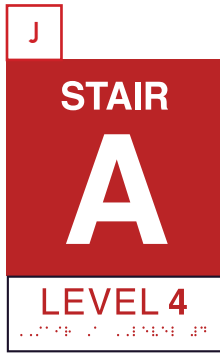

NOTE: ALL PREVIEWS SHOWN ARE NOT TO SCALE. ALL SIGN SIZES HAVE A HALF INCH ACCENT LINE AT BOTTOM

# ADA COMPLIANT SIGNS

## SIGN TYPE A-SE-203

- ADA compliant with Grade II Braille and tactile letters
- Zinc for outdoor and indoor use.
- Available In 6 Colors

Available in ONE size (H x W):  
8"x 6"

Choose color and text below, letters A thru F

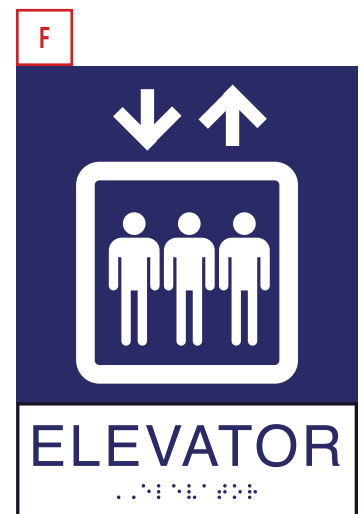

NOTE: ALL PREVIEWS SHOWN ARE NOT TO SCALE. ALL SIGN SIZES HAVE A HALF INCH ACCENT LINE AT BOTTOM

# RATE SIGNS+SIGN FRAME

## SIGN TYPE SF-100

- Aluminum fabricated sign frame
- Available In 2 Colors: Gold+Bronze

<h3>DAY RATES</h3> <table> <tr> <td>Up to ½ hr.</td> <td>\$15.21</td> </tr> <tr> <td>Up to 1 hr.</td> <td>\$19.43</td> </tr> <tr> <td>Up to 2 hrs.</td> <td>\$21.88</td> </tr> <tr> <td>Up to 3 hrs.</td> <td>\$25.35</td> </tr> <tr> <td>Up to 10 hrs.</td> <td>\$31.26</td> </tr> <tr> <td>Up to 24 hrs.</td> <td>\$46.46</td> </tr> </table> <p><b>18.375% NYC Parking Tax Extra</b></p>	Up to ½ hr.	\$15.21	Up to 1 hr.	\$19.43	Up to 2 hrs.	\$21.88	Up to 3 hrs.	\$25.35	Up to 10 hrs.	\$31.26	Up to 24 hrs.	\$46.46	<h3>MONTHLY</h3> <table> <tr> <td>Regular</td> <td>\$549.99</td> </tr> <tr> <td>Main Floor add</td> <td>\$126.72</td> </tr> <tr> <td>Reserved add</td> <td>\$ 26.72</td> </tr> <tr> <td>Oversize add</td> <td>\$ 84.47</td> </tr> </table>	Regular	\$549.99	Main Floor add	\$126.72	Reserved add	\$ 26.72	Oversize add	\$ 84.47	<h3>BK GARAGE</h3> <p>400 BROADWAY NEWYORK, NY</p> <p>CAPACITY: 200 LICENSE NO.: 123456</p>
Up to ½ hr.	\$15.21																					
Up to 1 hr.	\$19.43																					
Up to 2 hrs.	\$21.88																					
Up to 3 hrs.	\$25.35																					
Up to 10 hrs.	\$31.26																					
Up to 24 hrs.	\$46.46																					
Regular	\$549.99																					
Main Floor add	\$126.72																					
Reserved add	\$ 26.72																					
Oversize add	\$ 84.47																					
<p>The Department of Consumer Affairs of the City of New York has issued the following license to this business</p> <p>Licensee: BK GARAGE License Title(s): GARAGE License Numbers: 123456</p> <p>The Department of Consumer Affairs 42 Broadway, New York, NY 10004 Phone No: 212-487-4444</p> <p><small>NOTICE: Pursuant to law, operator's liability for loss or damage of vehicle by fire, theft, or explosion limited to \$25,000 unless additional fee paid when vehicle first parked and receipt issued for same.</small></p>		<h3>OPEN 24 HOURS 7 DAYS</h3>																				

Available in ONE size (H x W):  
48"x 96"

Choose color below, letters A or B.

This sign frame can hold a variety of interchangeable custom signs of your choice.

For sign sizes that fit this frame, see page 104 or you can make your own sizes to fit this frame.



**BRONZE ANODIZED**



**GOLD ANODIZED**

NOTE: ALL PREVIEWS SHOWN ARE NOT TO SCALE. ALL SIGN SIZES HAVE A HALF INCH ACCENT LINE AT BOTTOM

# RATE SIGNS+SIGN FRAME

## **SIGN TYPE C-SF-102, C-SF-102+C-SF-103**

- Aluminum fabricated sign frame
- Baked enamel finish

Available in ONE size (H x W):

44" x 44"  
22" x 22"  
12" x 14"

---

White background and black text for displaying garage information and rates.

Please provide the exact text you want when ordering your sign.

---

You may use the DESIGN YOUR OWN SIGN form (pg 123) located in the back of this catalog for customization. Also see page 103+116 for details.

---

### **DAY RATES**

<b>Up to ½ hr.</b>	<b>\$15.21</b>
<b>Up to 1 hr.</b>	<b>\$19.43</b>
<b>Up to 2 hrs.</b>	<b>\$21.88</b>
<b>Up to 3 hrs.</b>	<b>\$25.35</b>
<b>Up to 10 hrs.</b>	<b>\$31.26</b>
<b>Up to 24 hrs.</b>	<b>\$46.46</b>

**18.375% NYC Parking Tax Extra**

### **MONTHLY**

<b>Regular</b>	<b>\$549.99</b>
<b>Main Floor add</b>	<b>\$126.72</b>
<b>Reserved add</b>	<b>\$ 26.72</b>
<b>Oversize add</b>	<b>\$ 84.47</b>

**OPEN  
24 HOURS  
7 DAYS**

NOTE: ALL PREVIEWS SHOWN ARE NOT TO SCALE. ALL SIGN SIZES HAVE A HALF INCH ACCENT LINE AT BOTTOM

# TRAFFIC SIGNS

- Aluminum Fabricated Panel
- ReflectORIZED DOT standard
- Page 117 shows mounting details



R1-1



R5-1

Available in THREE sizes (H x W):  
24" x 24"  
30" x 30"  
36" x 36"



R8-3A



R9-3A



R3-1



R3-2



R3-4



R1-2

Available in THREE sizes (side x side x side):  
24" x 24" x 24"  
30" x 30" x 30"  
36" x 36" x 36"

NOTE: ALL PREVIEWS SHOWN ARE NOT TO SCALE. ALL SIGN SIZES HAVE A HALF INCH ACCENT LINE AT BOTTOM

# TRAFFIC SIGNS

- Aluminum Fabricated Panel
  - Reflectorized DOT standard
  - Page 117 shows mounting details
- Available in TWO sizes (H x W):  
24" x 18"  
30" x 24"



R6-2R



R6-2L



R2-1 (5)

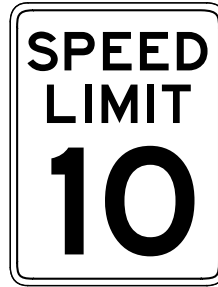

R2-1 (10)

Available in ONE size (H x W):  
12" x 36"



R6-1R



R6-1L

Available in TWO sizes (H x W):  
18" x 30"  
24" x 36"



R5-1A

NOTE: ALL PREVIEWS SHOWN ARE NOT TO SCALE. ALL SIGN SIZES HAVE A HALF INCH ACCENT LINE AT BOTTOM



# TRAFFIC SIGNS

- Aluminum Fabricated Panel
- Reflectorized DOT standard
- Page 117 shows mounting details

Available in ONE size (H x W):  
18"x 12"



R7-1L



R7-1R



R7-4



R7-8



R7-8N



G-40

Available in ONE size (H x W):  
6"x 12"



R7-8A



R7-8B

Available in TWO sizes (H x W):  
6"x 12"  
9"x 18"



R7-201

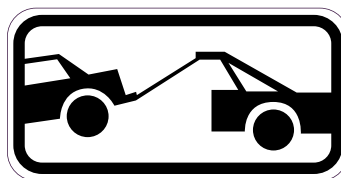

R7-201A

NOTE: ALL PREVIEWS SHOWN ARE NOT TO SCALE. ALL SIGN SIZES HAVE A HALF INCH ACCENT LINE AT BOTTOM

# OUR PARKING GARAGE SIGNAGE PROJECTS



## CITI FEILD / METS STADIUM, QUEENS, NY

# OUR PARKING GARAGE SIGNAGE PROJECTS

---

# OUR PARKING GARAGE SIGNAGE PROJECTS

---

NOTE: ALL PREVIEWS SHOWN ARE NOT TO SCALE. ALL SIGN SIZES HAVE A HALF INCH ACCENT LINE AT BOTTOM



# OUR PARKING GARAGE SIGNAGE PROJECTS

---

NOTE: ALL PREVIEWS SHOWN ARE NOT TO SCALE. ALL SIGN SIZES HAVE A HALF INCH ACCENT LINE AT BOTTOM

**SIGNS+DECAL**  
410 MORGAN AVE.  
BROOKLYN, NY 11211  
T | 718. 466. 6400  
F | 718. 388. 3166  
[www.signsanddecal.com](http://www.signsanddecal.com)  
[salesadmin@signsanddecal.com](mailto:salesadmin@signsanddecal.com)

# FABRICATION+INSTALLATION

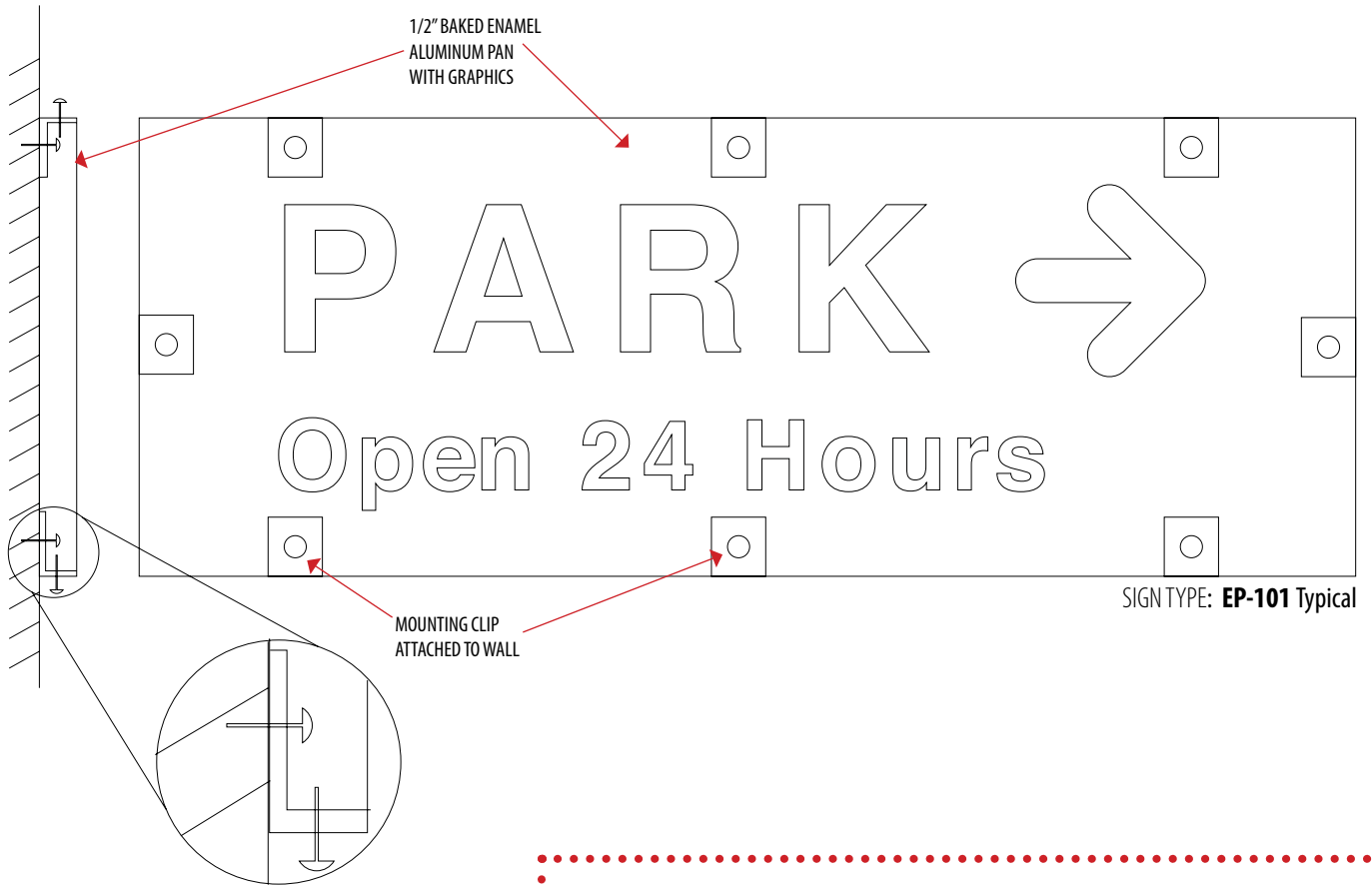

- SIGN TYPE: **EP-101**
  - SIGN TYPE: **EP-102**
  - SIGN TYPE: **EP-103**
  - SIGN TYPE: **EP-104**
  - SIGN TYPE: **EP-105**
  - SIGN TYPE: **EP-106**
  - SIGN TYPE: **EP-303**
- NTS  
 Single-Sided, Wall-Mounted  
 Non-Illuminated Pan Sign Panel  
 Sign Panel Typical  
 Size Varies

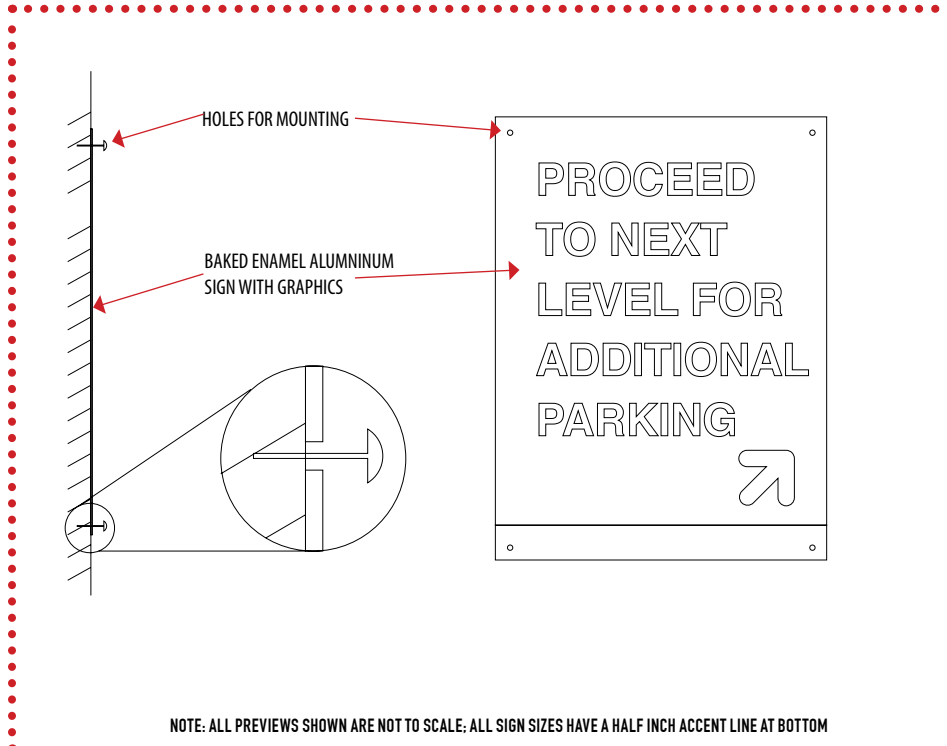

# FABRICATION+INSTALLATION

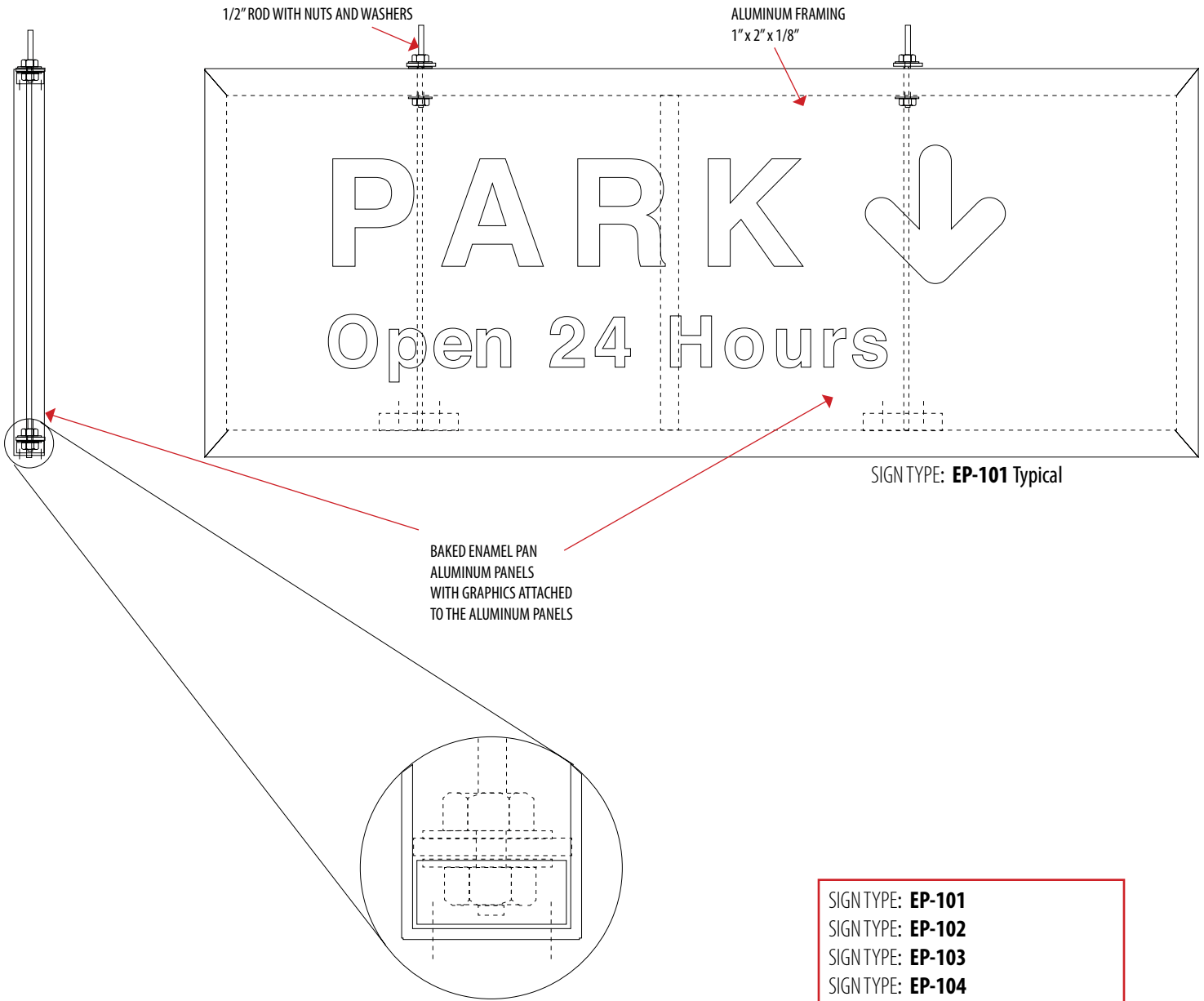

- SIGN TYPE: **EP-101**
- SIGN TYPE: **EP-102**
- SIGN TYPE: **EP-103**
- SIGN TYPE: **EP-104**
- SIGN TYPE: **EP-105**
- SIGN TYPE: **EP-106**
- SIGN TYPE: **EP-303**

NTS  
Single-Sided, Ceiling-Mounted  
Non-Illuminated Sign  
Size Varies

NOTE: ALL PREVIEWS SHOWN ARE NOT TO SCALE. ALL SIGN SIZES HAVE A HALF INCH ACCENT LINE AT BOTTOM

# FABRICATION+INSTALLATION

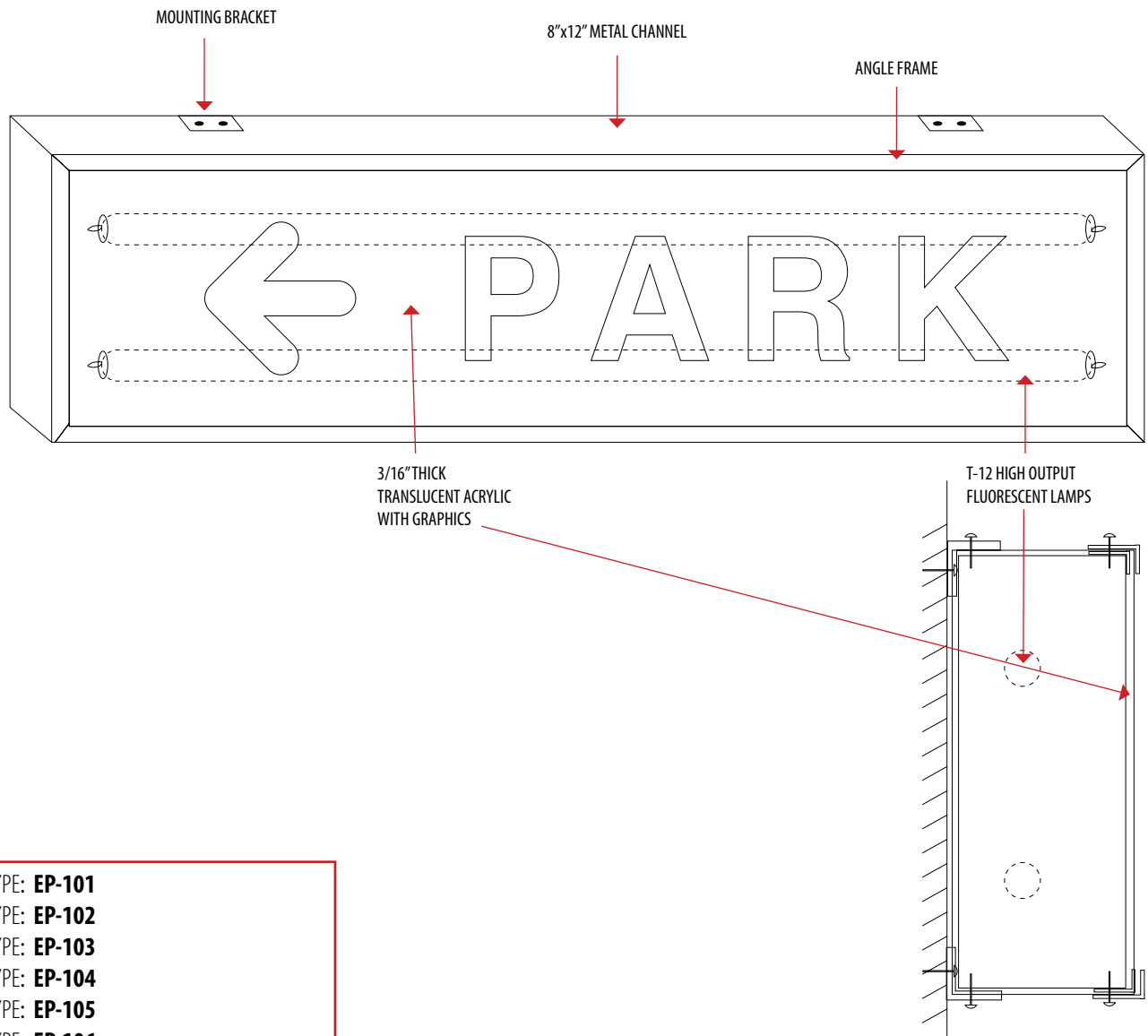

SIGN TYPE: **EP-101**

SIGN TYPE: **EP-102**

SIGN TYPE: **EP-103**

SIGN TYPE: **EP-104**

SIGN TYPE: **EP-105**

SIGN TYPE: **EP-106**

SIGN TYPE: **EP-107**

NTS

Single-Sided, Wall-Mounted

Internally-Illuminated sign

Size Varies

NOTE: ALL PREVIEWS SHOWN ARE NOT TO SCALE. ALL SIGN SIZES HAVE A HALF INCH ACCENT LINE AT BOTTOM



# FABRICATION+INSTALLATION

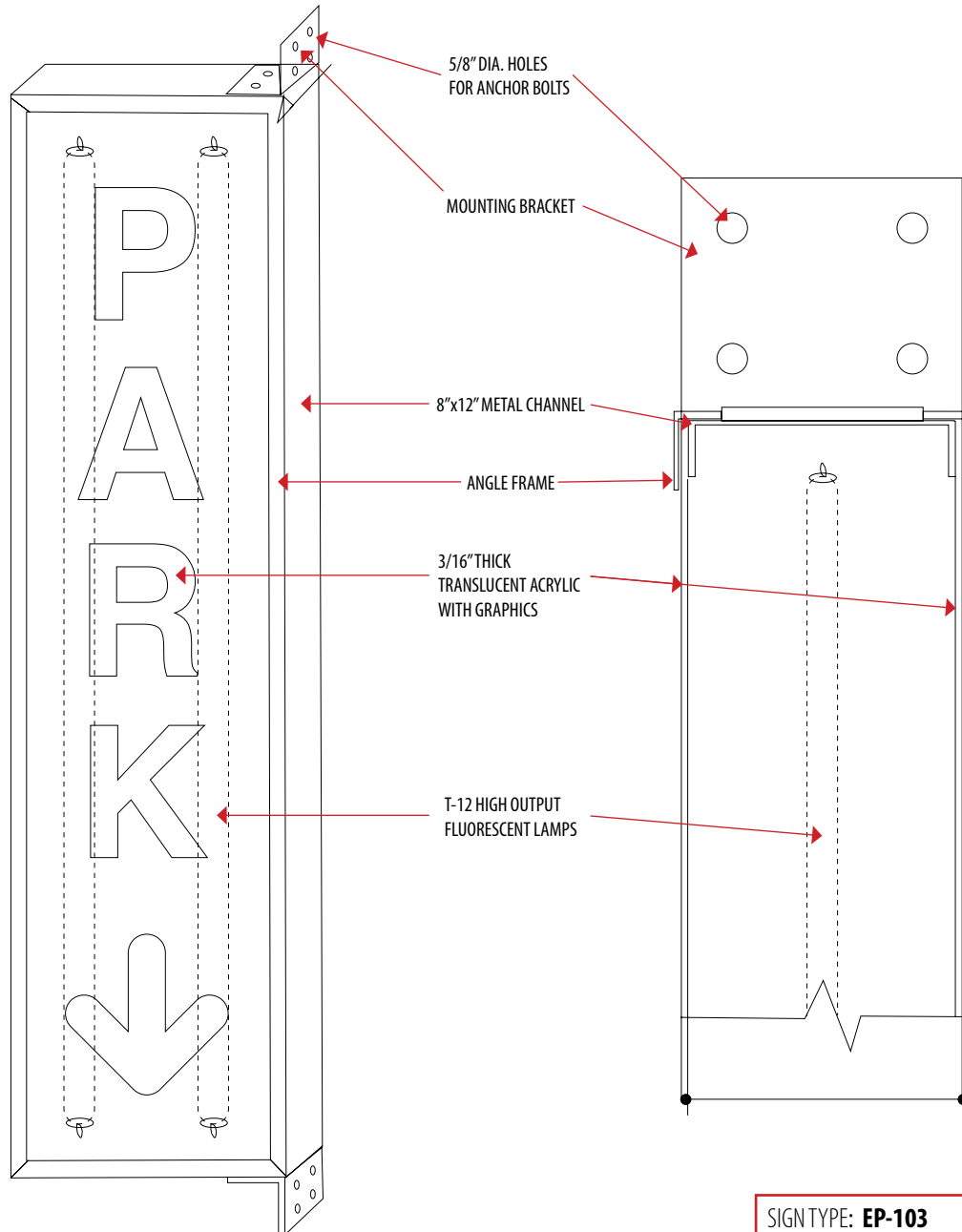

SIGN TYPE: **EP-103**

NTS

Double-Sided

Internally-Illuminated Vertical Sign

Size Varies: 12"x 48"x 8" to 12" Deep

18"x 72"x 8" to 12" Deep

18"x 96"x 8" to 12" Deep

NOTE: ALL PREVIEWS SHOWN ARE NOT TO SCALE. ALL SIGN SIZES HAVE A HALF INCH ACCENT LINE AT BOTTOM

**SIGNS+DECAL**

410 MORGAN AVE.

BROOKLYN, NY 11211

T | 718. 466. 6400

F | 718. 388. 3166

www.signsanddecal.com

salesadmin@signsanddecal.com

# FABRICATION+INSTALLATION

GOLD / BRONZE ANODIZED  
ALUMINUM FRAMING

BAKED ENAMEL WHITE  
ALUMINUM PANEL WITH  
BLACK GRAPHICS

**DAY RATES**

Up to ½ hr.	\$15.21
Up to 1 hr.	\$19.43
Up to 2 hrs.	\$21.88
Up to 3 hrs.	\$25.35
Up to 10 hrs.	\$31.26
Up to 24 hrs.	\$46.46

**18.375% NYC Parking Tax Extra**

**MONTHLY**

Regular	\$549.99
Main Floor add	\$126.72
Reserved add	\$ 26.72
Oversize add	\$ 84.47

**BK GARAGE**

400 BROADWAY  
NEWYORK, NY

CAPACITY: 200  
LICENSE NO.: 123456

**OPEN  
24 HOURS  
7 DAYS**

The Department of Consumer Affairs of the City of New York has issued the following license to this business

Licensee: BK GARAGE  
License Title(s): GARAGE  
License Numbers: 123456

The Department of Consumer Affairs  
42 Broadway, New York, NY 10004  
Phone No: 212-487-4444

NOTICE: Pursuant to law, operator's liability for loss or damage of vehicle by fire, theft, or explosion limited to \$25,000 unless additional fee paid when vehicle first parked and receipt issued for same.

GOLD / BRONZE ANODIZED  
BACKGROUND

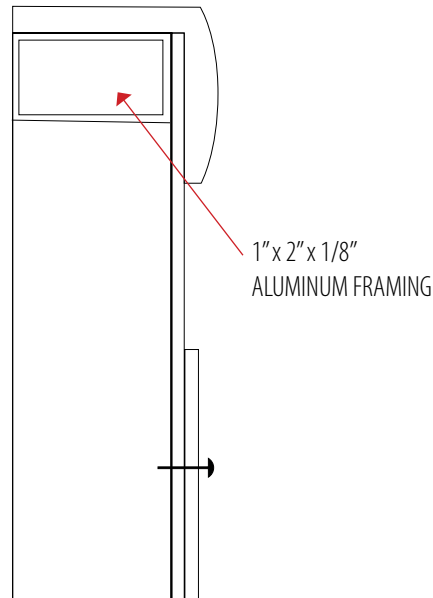

NTS  
Rate Sign  
4' x 8' x 2" Deep  
Gold or bronze anodized aluminum plaque  
with white baked enamel sign panels with graphics  
Size Varies

NOTE: ALL PREVIEWS SHOWN ARE NOT TO SCALE. ALL SIGN SIZES HAVE A HALF INCH ACCENT LINE AT BOTTOM



# FABRICATION+INSTALLATION

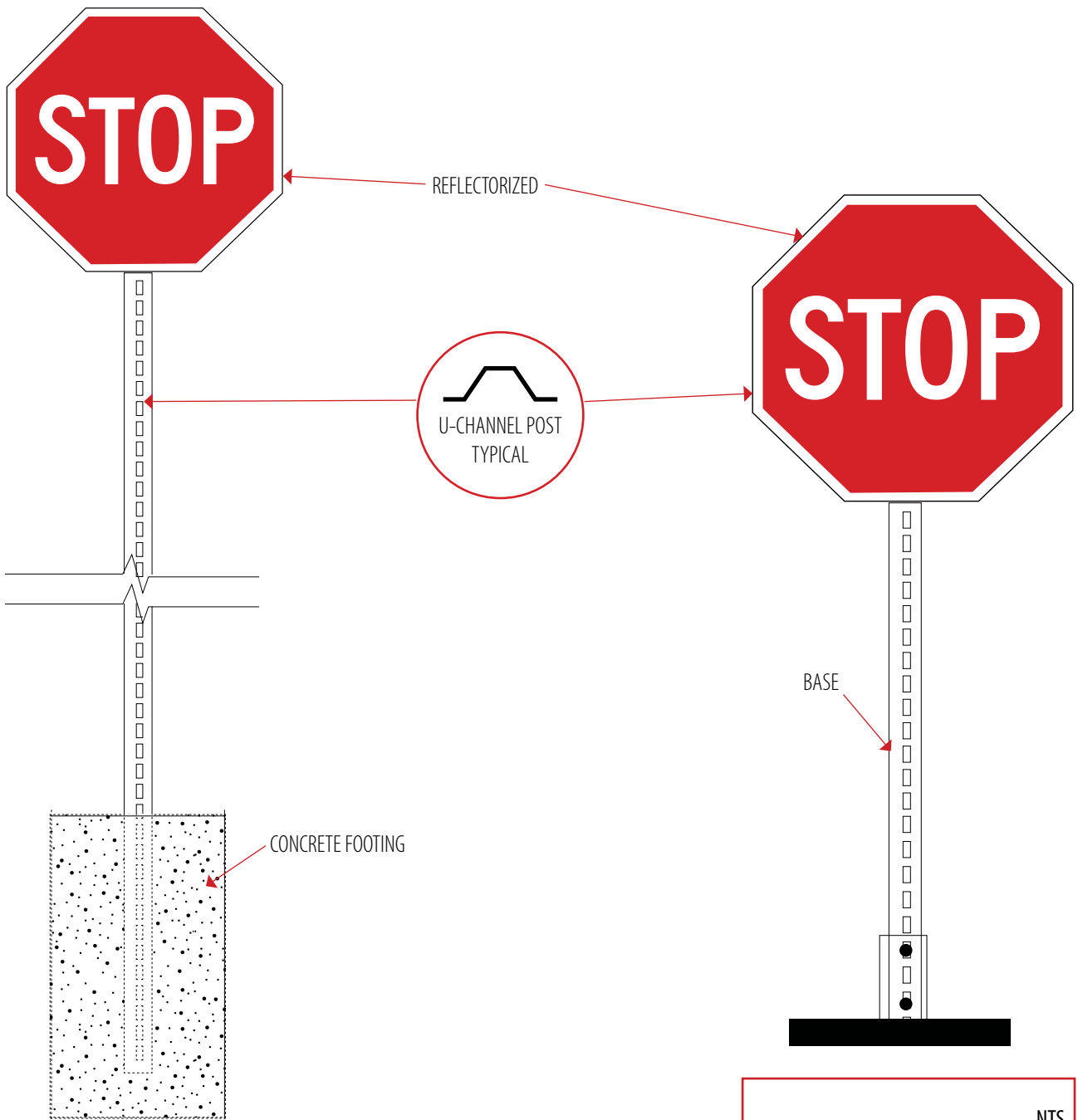

NTS  
Ground-mounted and free-standing signs  
Any sign can be attached to these posts  
Size varies

NOTE: ALL PREVIEWS SHOWN ARE NOT TO SCALE. ALL SIGN SIZES HAVE A HALF INCH ACCENT LINE AT BOTTOM

**SIGNS+DECAL**  
410 MORGAN AVE.  
BROOKLYN, NY 11211  
T | 718. 466. 6400  
F | 718. 388. 3166  
www.signsanddecal.com  
salesadmin@signsanddecal.com

# FABRICATION+INSTALLATION

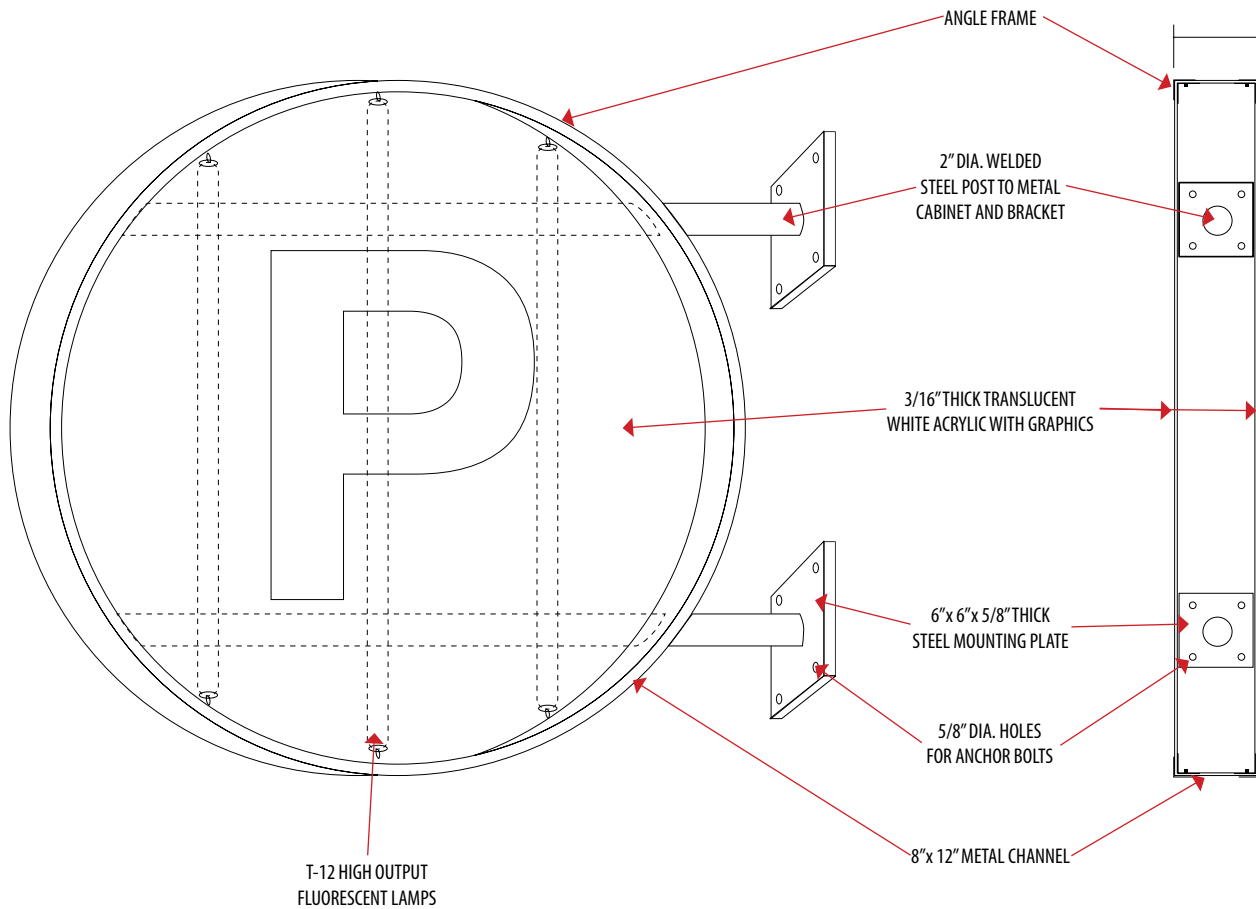

SIGN TYPE: **EP-401**

NTS

Double-Sided

Internally-Illuminated Vertical Sign

Size Varies: 30" Dia. x 8" to 12" Deep

36" Dia. x 8" to 12" Deep

48" Dia. x 8" to 12" Deep

NOTE: ALL PREVIEWS SHOWN ARE NOT TO SCALE. ALL SIGN SIZES HAVE A HALF INCH ACCENT LINE AT BOTTOM

# FABRICATION+INSTALLATION



SIGN TYPE: **C-CL-101**- 72" OR 96" LONG



SIGN TYPE: **C-CL-102**- 72" OR 96" LONG

CLOSED CAPS AT BOTH ENDS

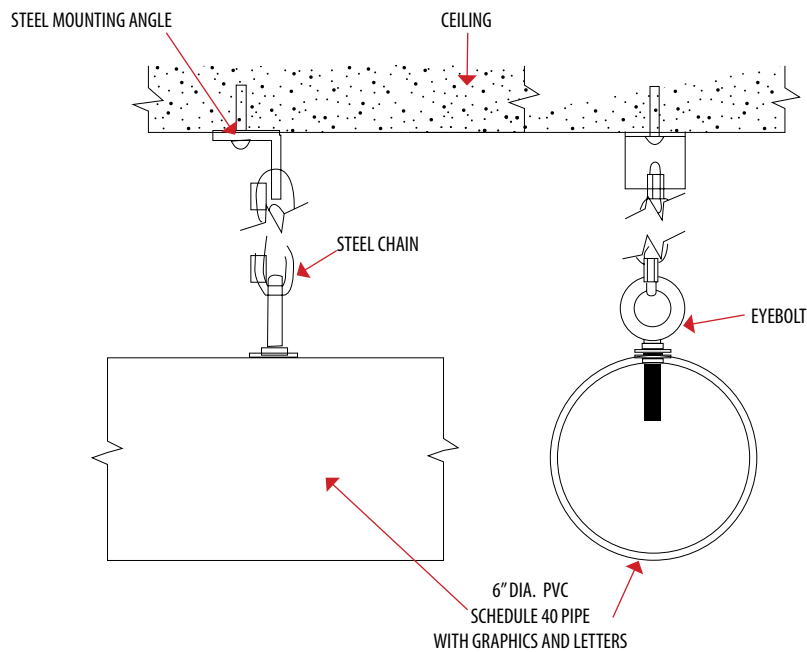

NOTE: ALL PREVIEWS SHOWN ARE NOT TO SCALE. ALL SIGN SIZES HAVE A HALF INCH ACCENT LINE AT BOTTOM

# ORDERING INFORMATION

- Our Prices Are Based On The Size And Type Of Sign
- Please Indicate What Type Of Sign You Want To Order

<b>PAGE #</b>	Page you wish to order from
<b>SIGN TYPE</b>	RG-201
<b>SIGN SIZE</b>	8" x 32"
<b>TEXT/COLOR</b>	Choose A thru O
<b>QTY.</b>	Quantity you wish to order
<b>PRICE</b>	\$

## EXAMPLE:

### ORDER FORM

---

ITEM	PAGE	SIGN TYPE	SIZE	COLOR/TEXT	QTY.	PRICE	TOTAL
1	37	RG-201	8" x 32"	H	3	\$	\$
2	38	EX-201	16" x 12"	G	5	\$	\$



# ORDER FORM

ITEM	PAGE	SIGN TYPE	SIZE	COLOR/TEXT	QTY.	PRICE	TOTAL
1							
2							
3							
4							
5							
6							
7							
8							
9							
10							

**METHODS OF PAYMENT ( CIRCLE )**

Check or money order enclosed, payable to Signs+Decal Corp.



Name on Card: .....

Credit Card No.: .....Exp Date: .....

Signature: .....

TOTAL

SALES TAX

SHIPPING+HANDLING

GRAND TOTAL

**DELIVER MY ORDER TO:**

Name:.....Email:.....

Company Name: .....

Company Address: .....

City:.....State:.....Zip:.....

Phone: .....Fax: .....

**SIGNS+DECAL**

410 MORGAN AVE.  
 BROOKLYN, NY 11211  
 T | 718. 466. 6400  
 F | 718. 388. 3166  
 www.signsanddecal.com  
 salesadmin@signsanddecal.com





# NOTES

---

.....

.....

.....

.....

.....

.....

.....

.....

.....

.....

.....

.....

.....

.....

.....

.....

.....

.....

.....

.....

.....

.....

.....